

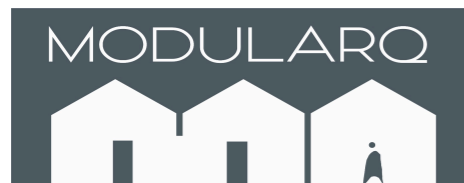

**PLANTA ARQUITECTÓNICA CASA HABITACIÓN**  
1ER NIVEL

**UBICACIÓN DE USUARIO**

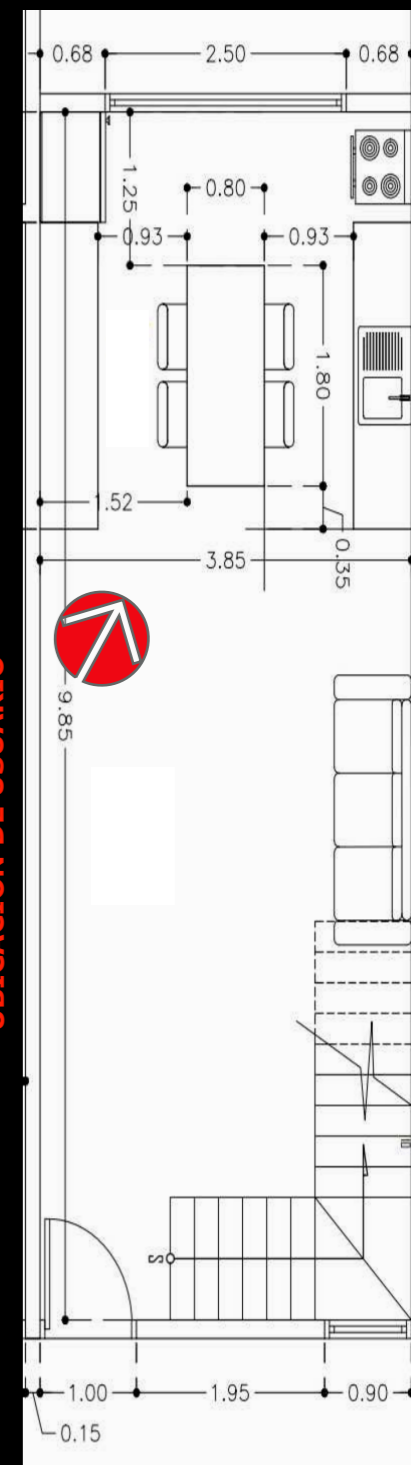

**RENDER**  
DISEÑO DE COCINA

PROYECTO:  
DISEÑO DE COCINA - CASA INESTROZA  
CLIENTE: -----

ARQ. JORGE SANTOS

**01/22**

PLANTA ARQUITECTÓNICA CASA HABITACIÓN  
1ER NIVEL

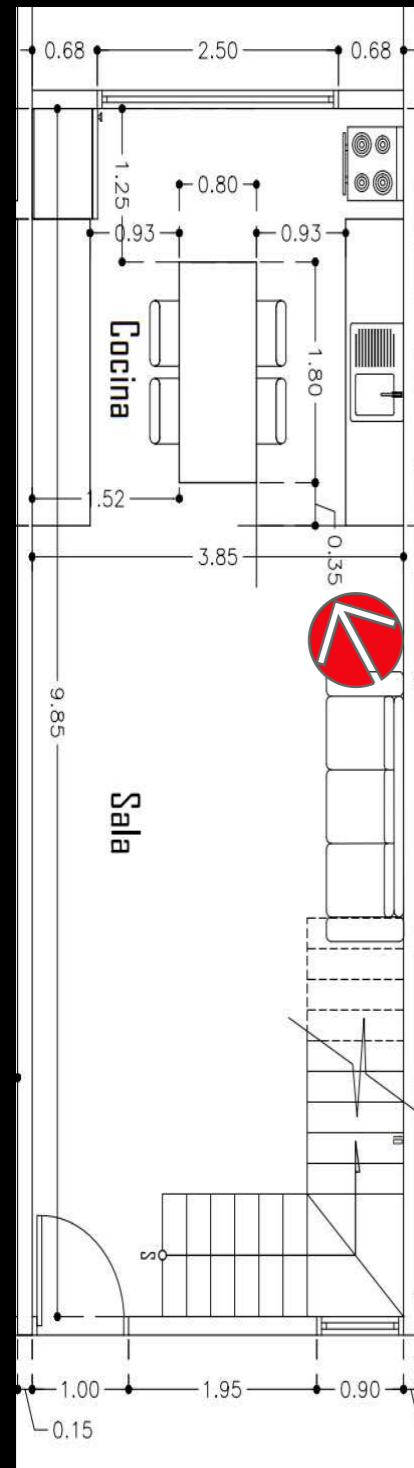

UBICACIÓN DE USUARIO



**RENDER**  
DISEÑO DE COCINA

PROYECTO:  
DISEÑO DE COCINA - CASA INESTROZA  
CLIENTE: -----

ARQ. JORGE SANTOS

02/22





ISOMETRICO



ISOMETRICO



ISOMETRICO

• **MUEBLE 01**



VISTA FRONTAL

• **MUEBLE 02**

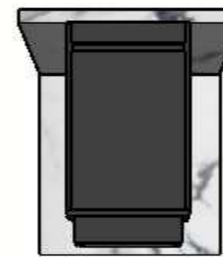

VISTA FRONTAL

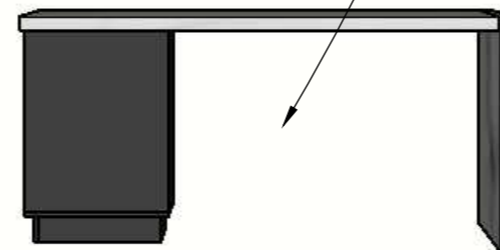

VISTA LATERAL

• **MUEBLE 03**

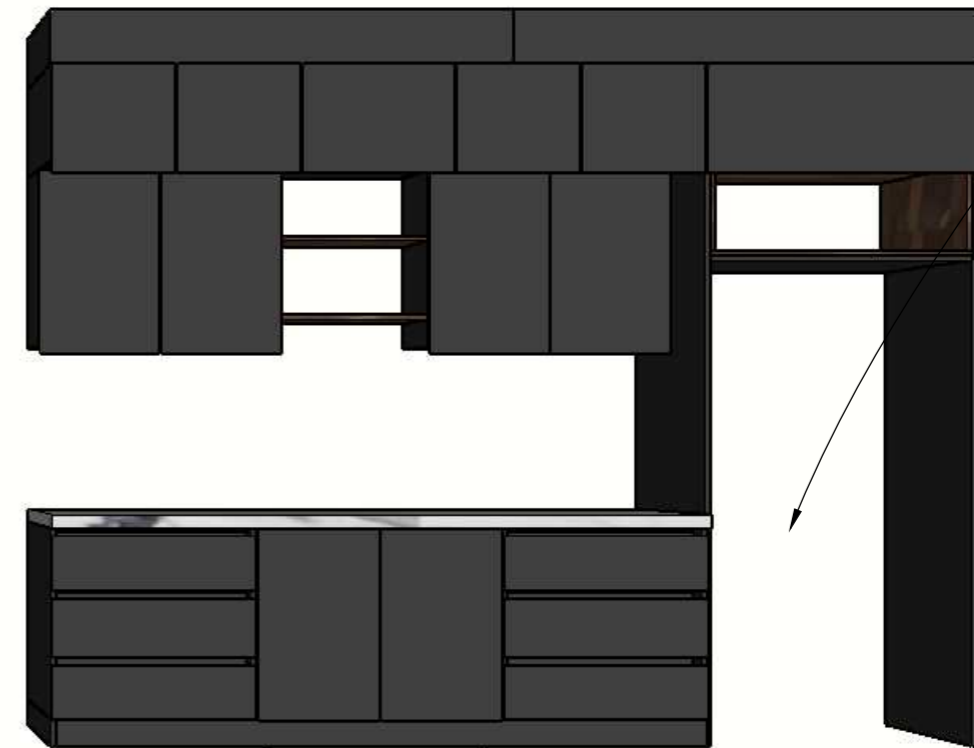

VISTA FRONTAL



**CLASIFICACIÓN DE MUEBLE**  
DISEÑO DE COCINA

PROYECTO:  
DISEÑO DE COCINA - CASA INESTROZA  
CLIENTE: -----

ARQ. JORGE SANTOS

**03/22**

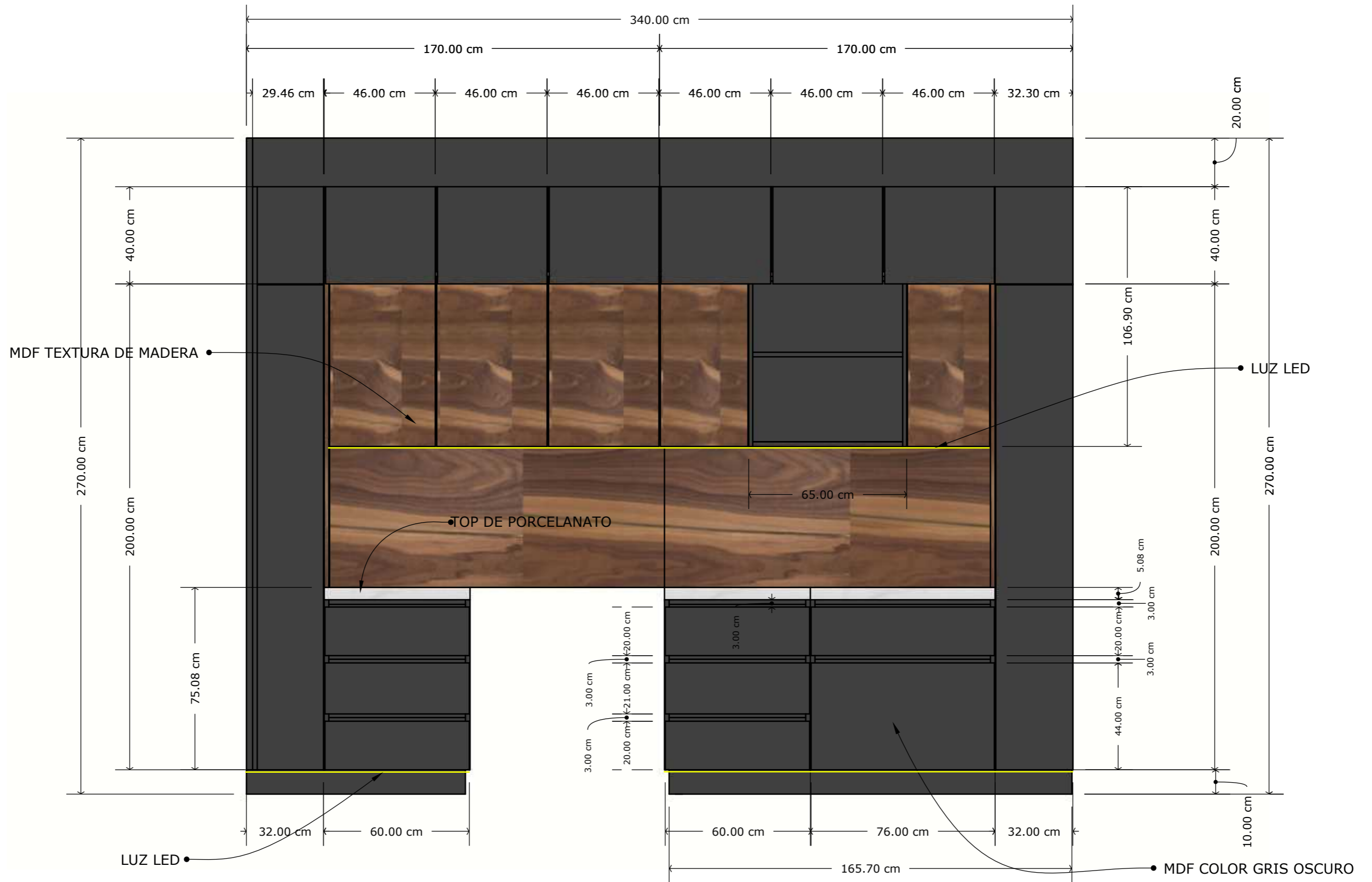

**VISTA FRONTAL MUEBLE 01**  
MEDIDAS GENERALES

PROYECTO:  
DISEÑO DE COCINA - CASA INESTROZA  
CLIENTE: -----

ARQ. JORGE SANTOS

**04/22**

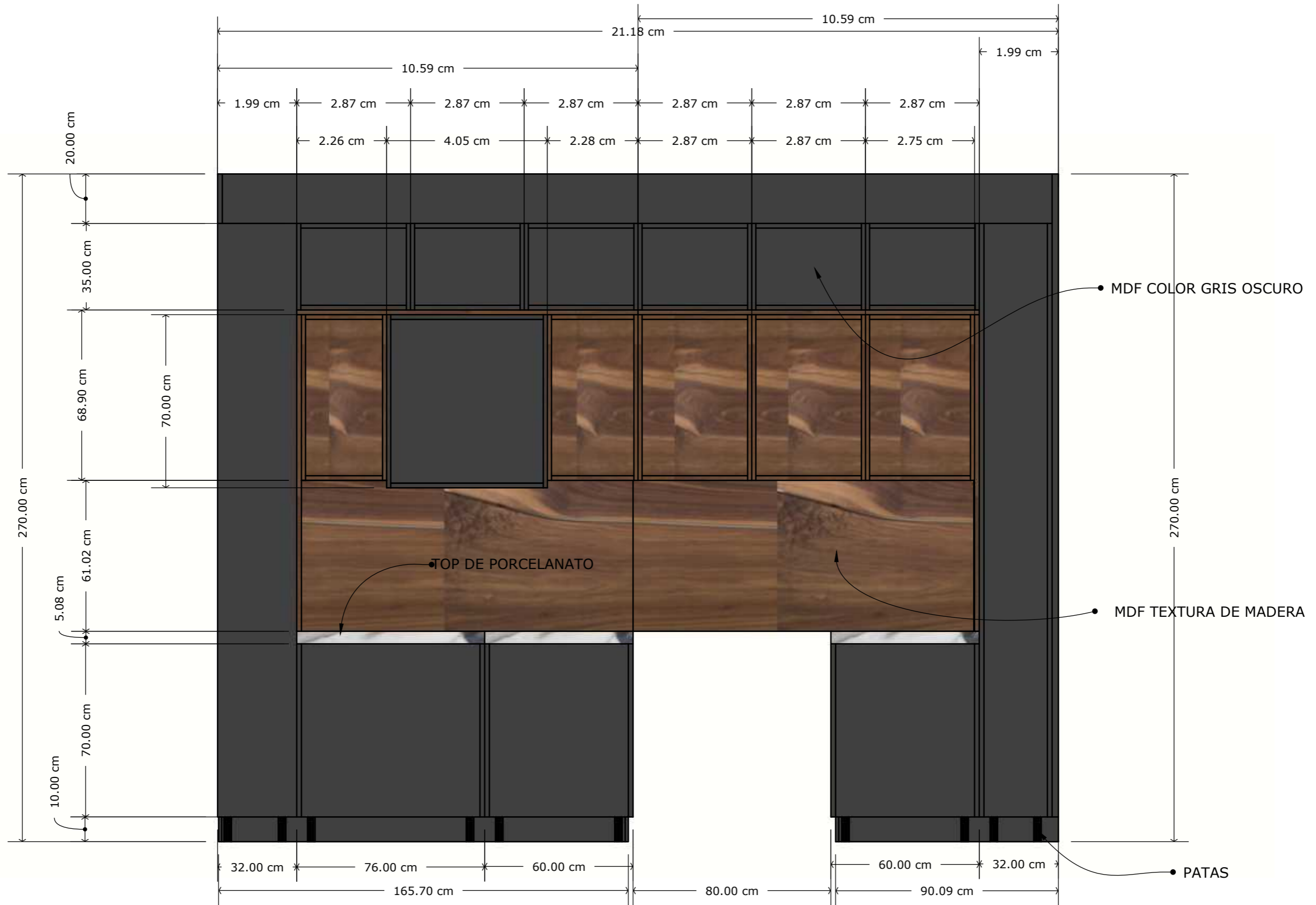

**VISTA POSTERIOR MUEBLE 01**  
MEDIDAS GENERALES

PROYECTO:  
DISEÑO DE COCINA - CASA INESTROZA  
CLIENTE: -----

ARQ. JORGE SANTOS

**05/22**

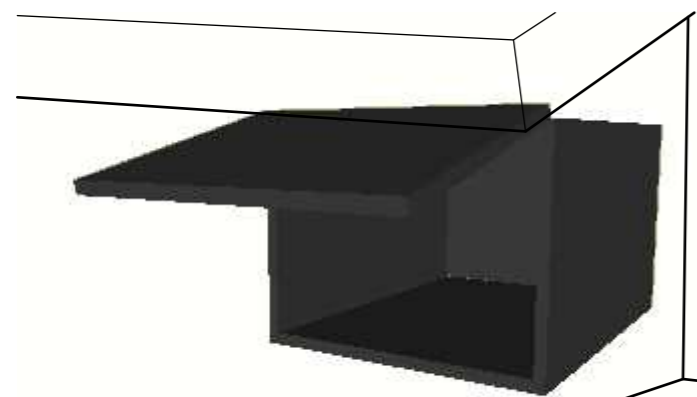

ISOMETRICO

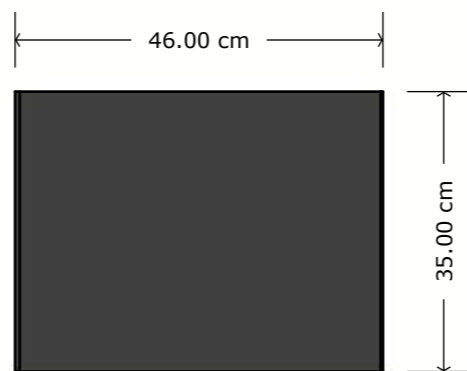

VISTA FRONTAL

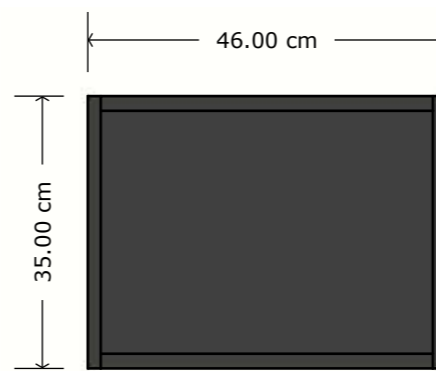

VISTA POSTERIOR

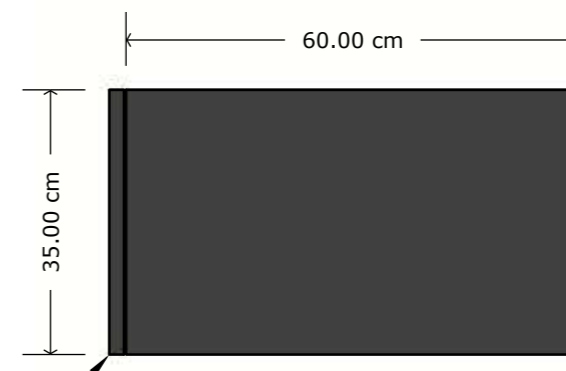

VISTA LATERAL

• PUERTA CON PUSH PARA APERTURA



• DETALLE DE CAJONES SUPERIORES

• MDF COLOR GRIS OSCURO

VISTA SUPERIOR MUEBLE 01

• APERTURA DE PUERTAS HACIA ARRIBA.

• PIEZA CON PUSH APERTURA HACIA ARRIBA

• PIEZA FIJA

VISTA FRONTAL - FUNCIONAMIENTO Y DIMENSIONES DE GAVETAS



**DETALLES MUEBLE 01**  
MEDIDAS GENERALES

PROYECTO:  
DISEÑO DE COCINA - CASA INESTROZA  
CLIENTE: -----

ARQ. JORGE SANTOS

**06/22**

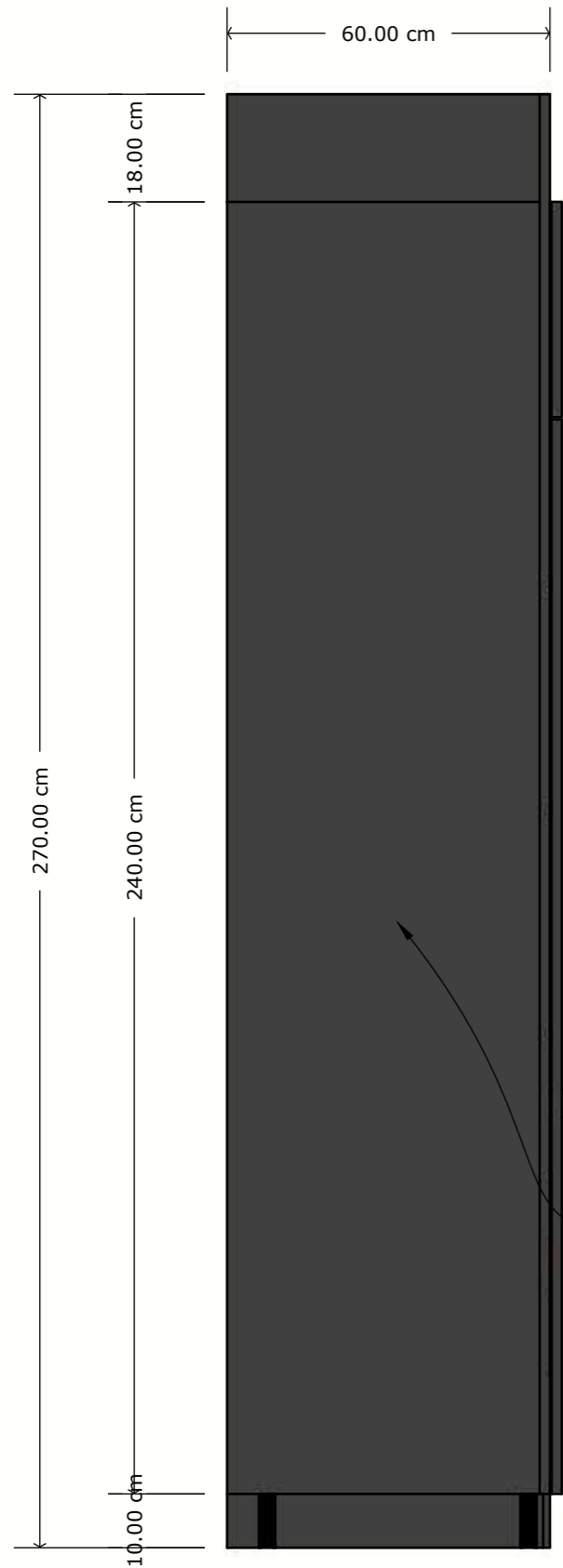

VISTA LATERAL IZQUIERDA MUEBLE 01

• MDF COLOR GRIS OSCURO

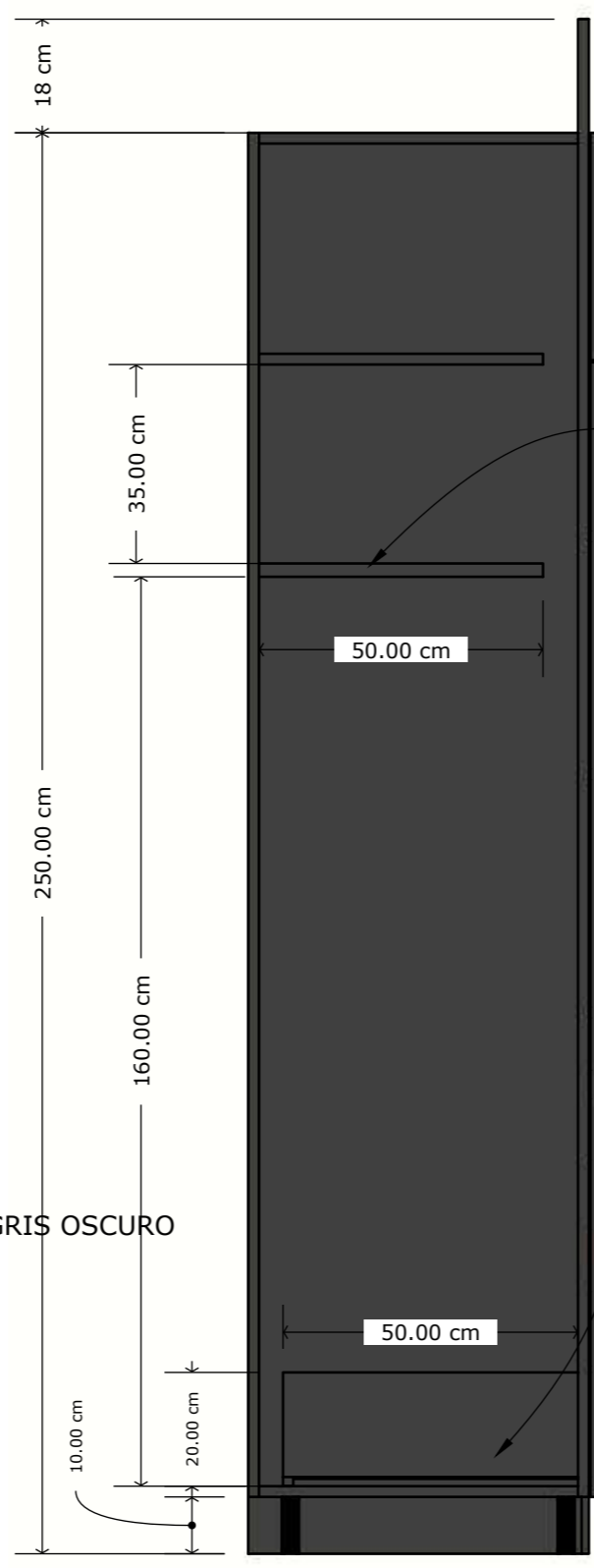

VISTA LATERAL IZQUIERDA MUEBLE 01

SIN PANEL O PARED LATERAL  
VISTA PARA VER INTERIOR DE MUEBLE

• REPISAS

• GAVETA FIJA  
SEPARADA DEL PANEL INFERIOR

MDF TEXTURA DE MADERA

TOP DE PORCELANATO

ESPACIO PARA ESCOBAS  
TRAPEADORES Y PRODUCTOS  
DE ASEO.

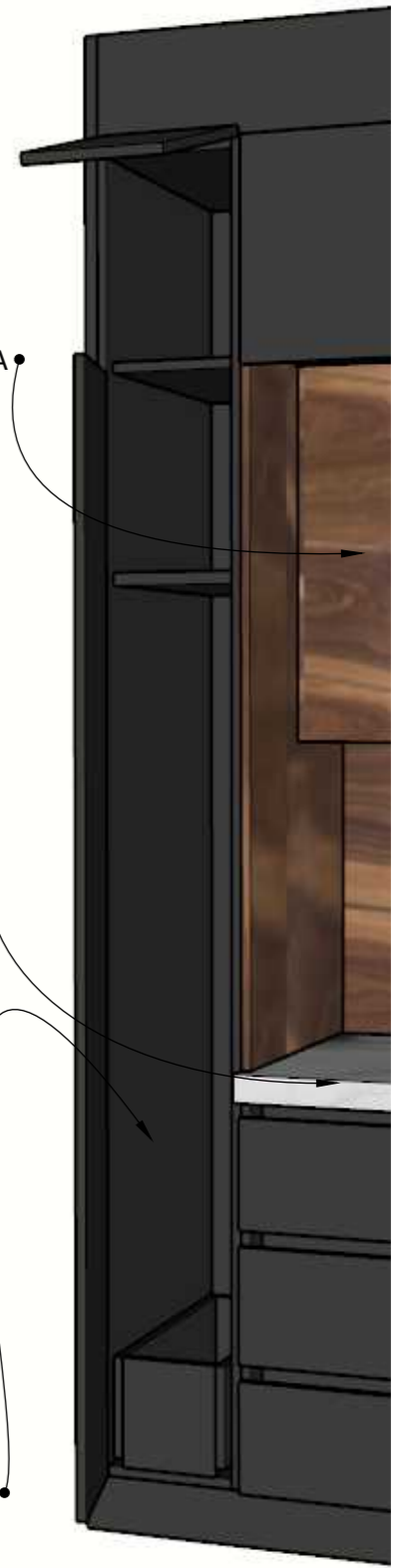

VISTA APERTURA DE PUERTAS

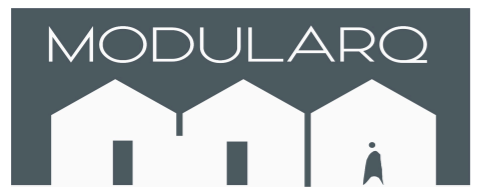

**DETALLES MUEBLE 01**  
MEDIDAS GENERALES

PROYECTO:  
DISEÑO DE COCINA - CASA INESTROZA  
CLIENTE: -----

ARQ. JORGE SANTOS

**07/22**



VISTA APERTURA DE PUERTAS

VISTA LATERAL DERECHA MUEBLE 01

VISTA LATERAL DERECHA MUEBLE 01



**DETALLES MUEBLE 01**  
MEDIDAS GENERALES

PROYECTO:  
DISEÑO DE COCINA - CASA INESTROZA  
CLIENTE: -----

ARQ. JORGE SANTOS

**08/22**



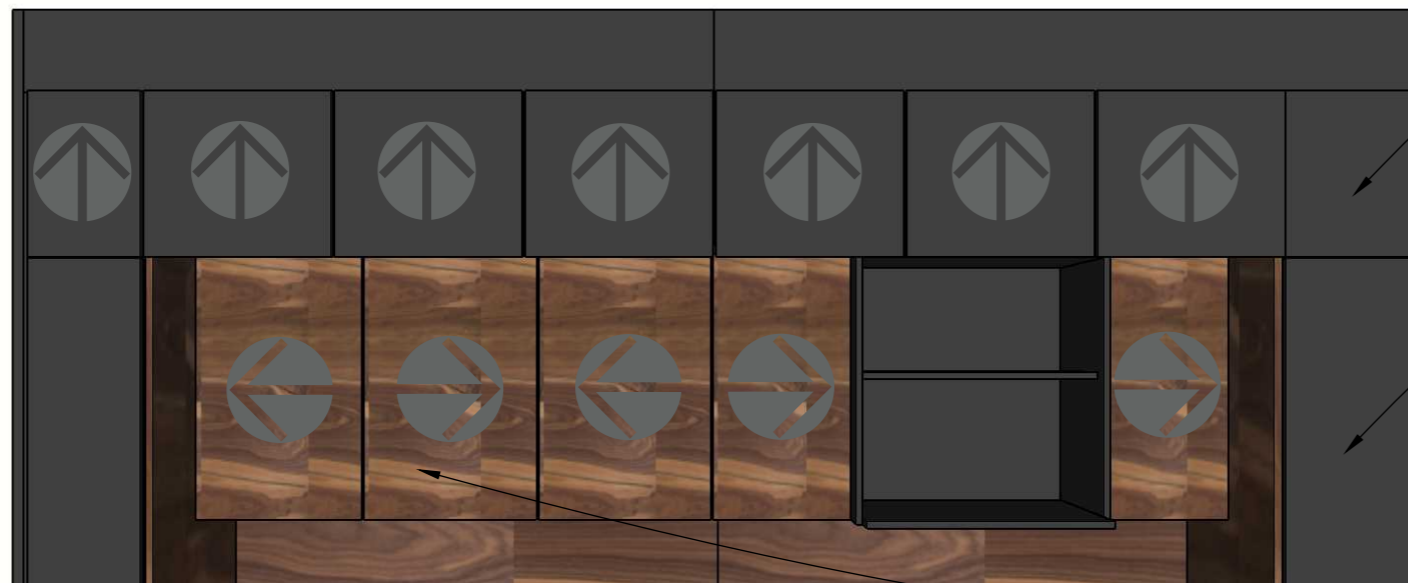

VISTA FRONTAL MUEBLE 01 INCAPIE EN APERTURA DE PUERTAS

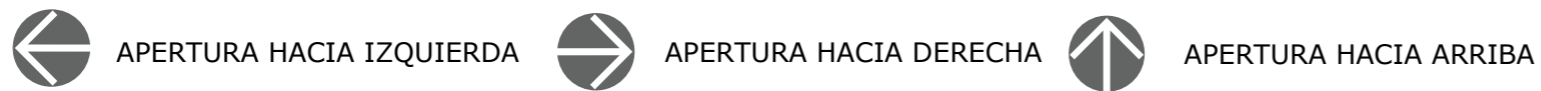

VISTA LATERAL



**DETALLES MUEBLE 01**  
MEDIDAS GENERALES

PROYECTO:  
DISEÑO DE COCINA - CASA INESTROZA  
CLIENTE: -----

ARQ. JORGE SANTOS

**09/22**

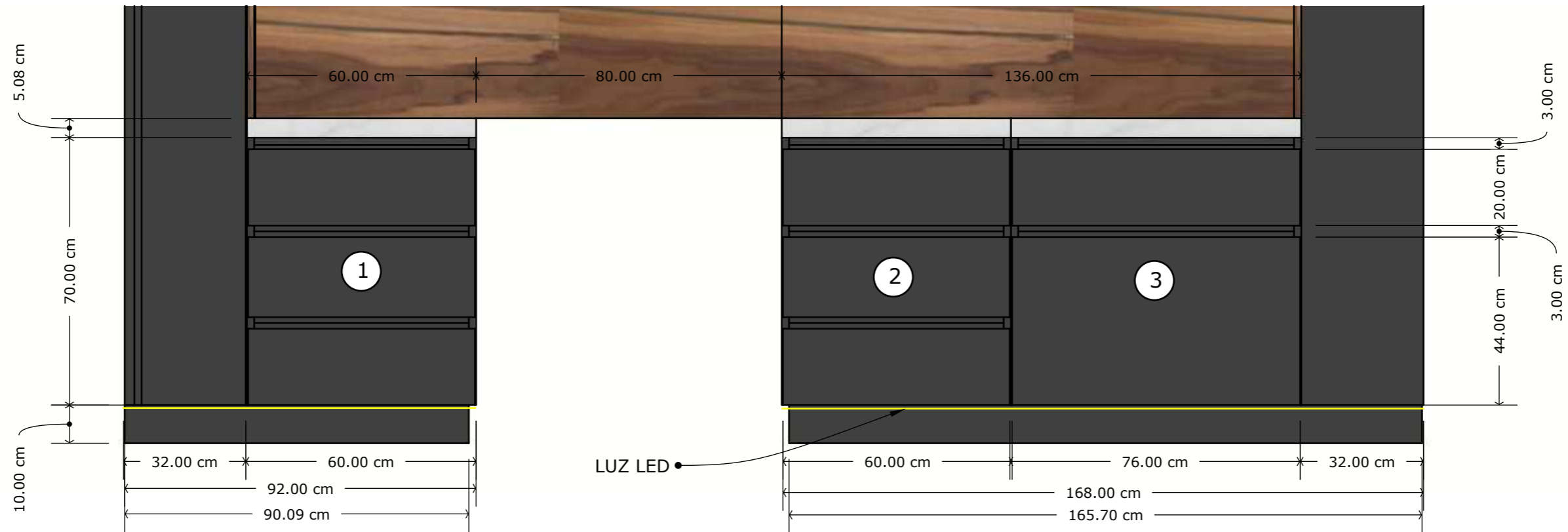

VISTA FRONTAL - FUNCIONAMIENTO Y DIMENSIONES DE GAVETAS



ISOMETRICO ① ②

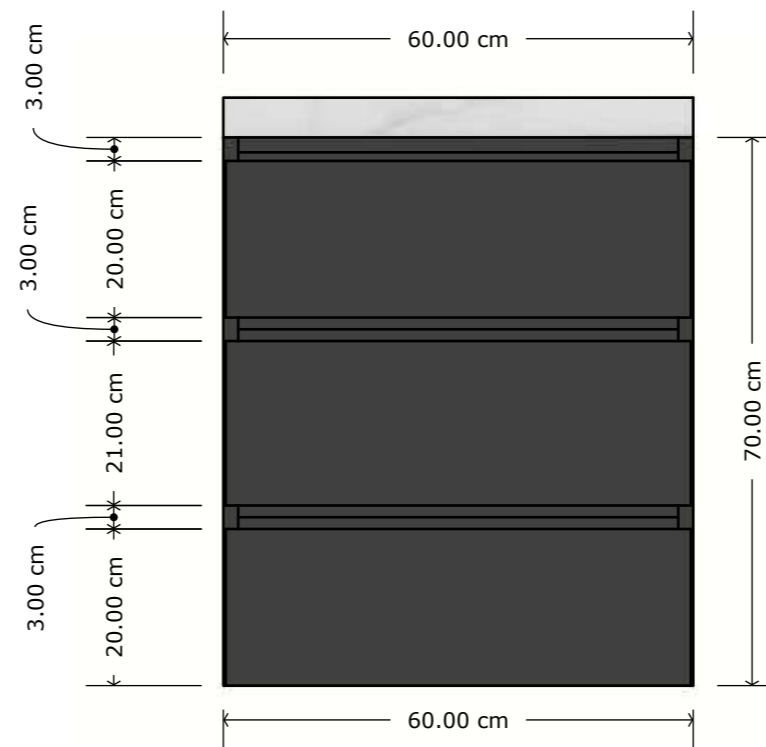

VISTA FRONTAL ① ②

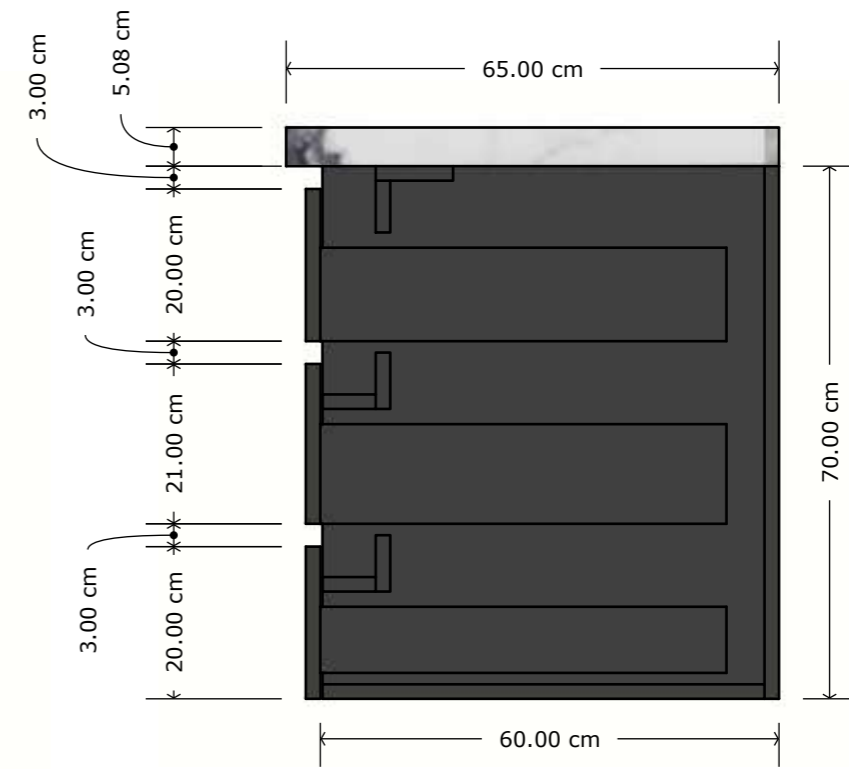

VISTA LATERAL ① ②

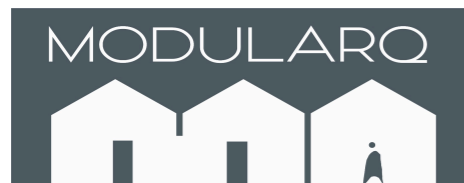

**DETALLES MUEBLE 01**  
MEDIDAS GENERALES GAVETEROS

PROYECTO:  
DISEÑO DE COCINA - CASA INESTROZA  
CLIENTE: -----

ARQ. JORGE SANTOS

10/22

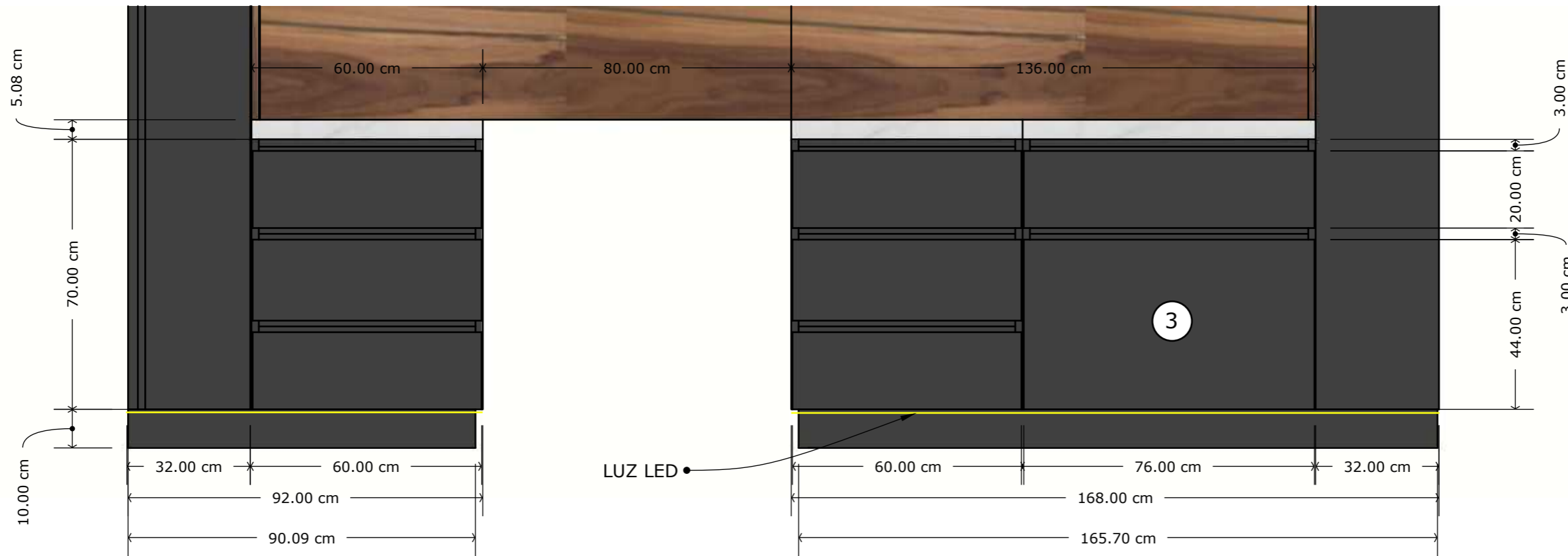

VISTA FRONTAL - FUNCIONAMIENTO Y DIMENSIONES DE GAVETAS



ISOMETRICO (3)

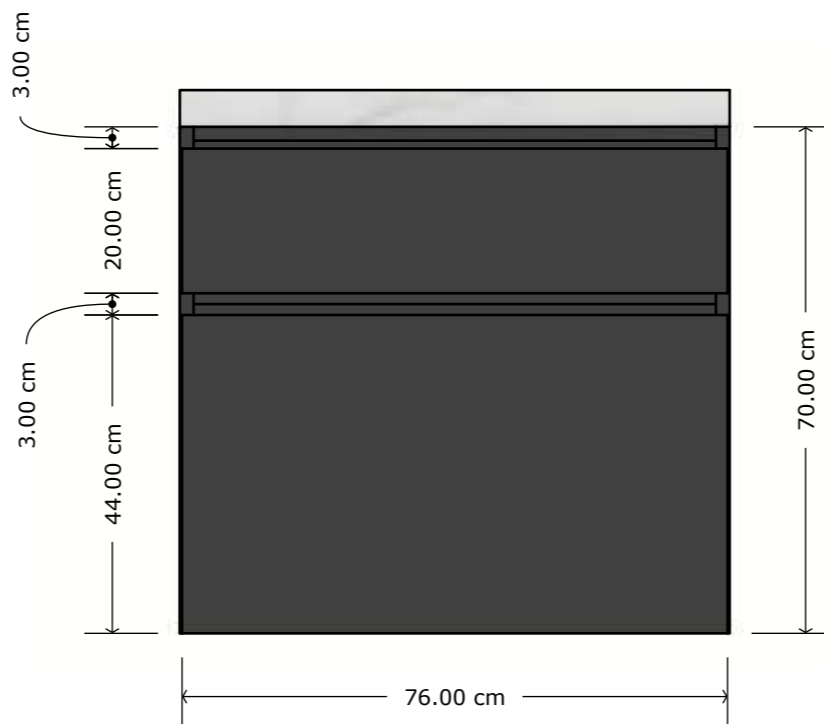

VISTA FRONTAL (3)

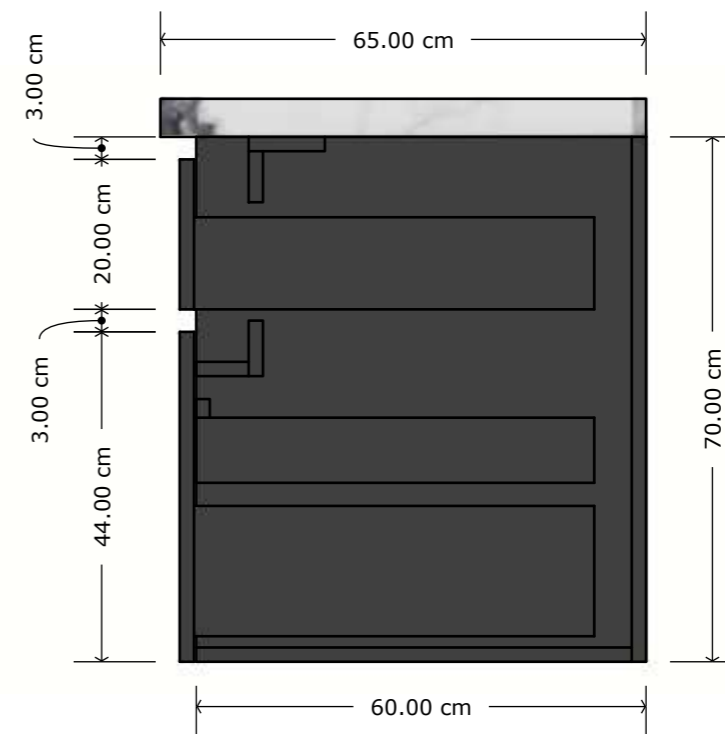

VISTA LATERAL (3)



**DETALLES MUEBLE 01**  
MEDIDAS GENERALES GAVETEROS

PROYECTO:  
DISEÑO DE COCINA - CASA INESTROZA  
CLIENTE: -----

ARQ. JORGE SANTOS

11/22



**ISOMETRICO / DETALLE TOP DE PORCELANATO**

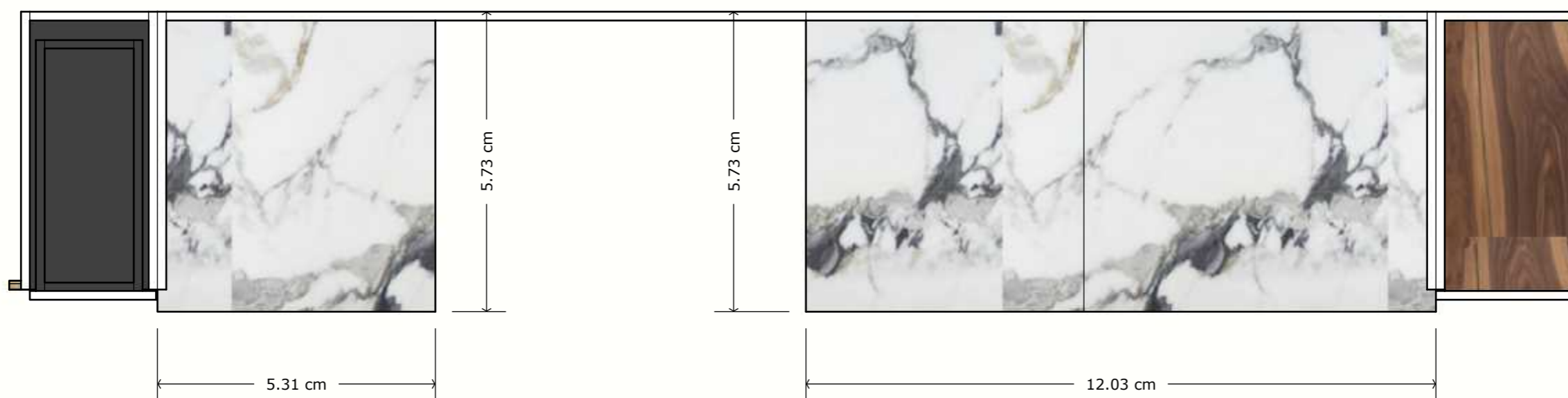

**VISTA EN PLANTA MUEBLE 01**  
TOP DE PORCELANATO



**DETALLES TOP DE COCINA 01**  
MEDIDAS GENERALES TOP

PROYECTO:  
DISEÑO DE COCINA - CASA INESTROZA  
CLIENTE: -----

ARQ. JORGE SANTOS

**12/22**



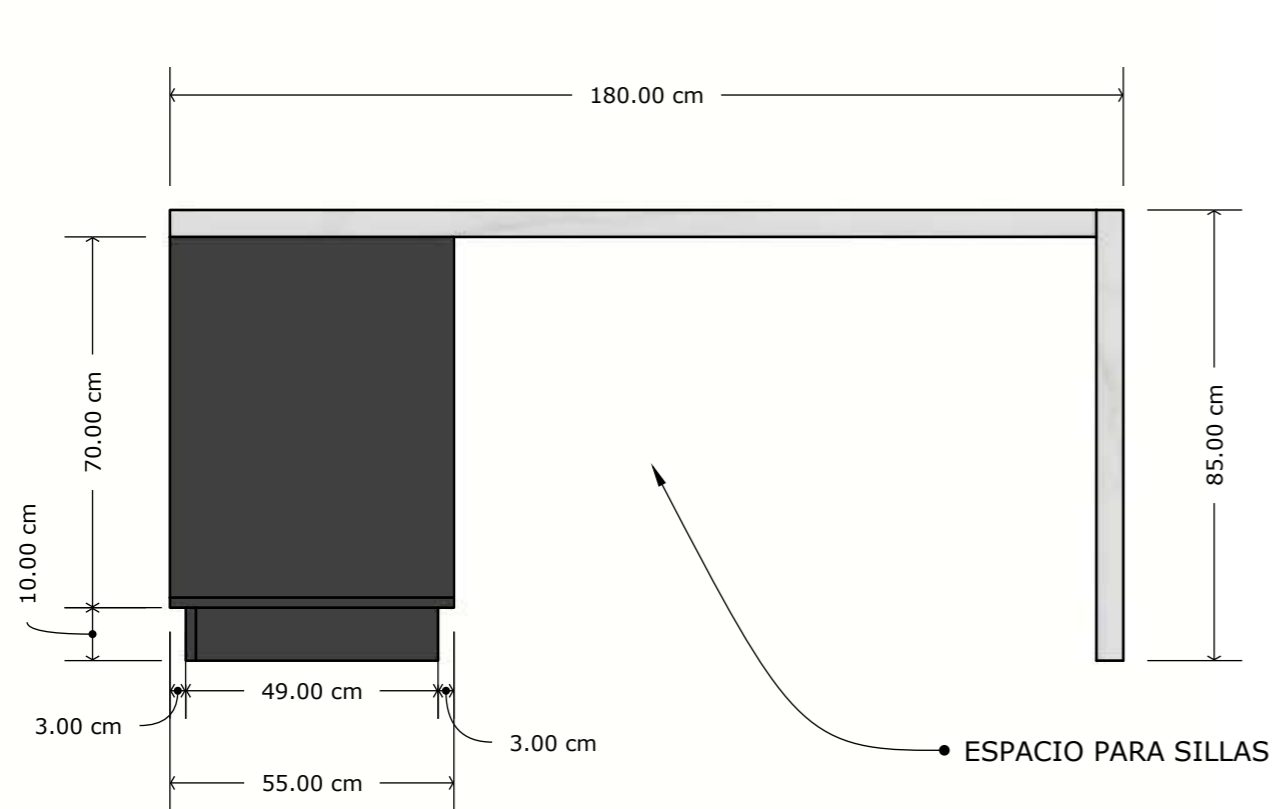

VISTA LATERAL

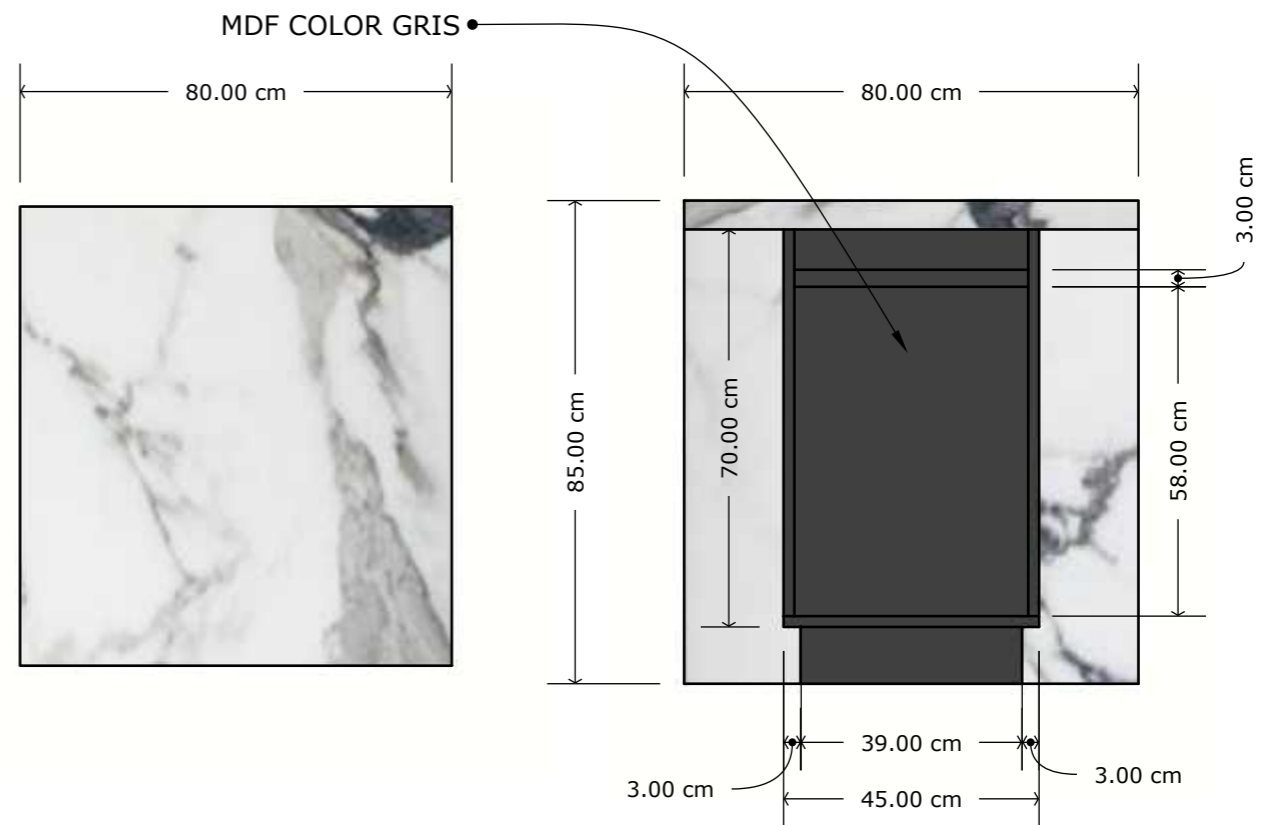

VISTA TRASERA

VISTA FRONTAL



ISOMETRICO

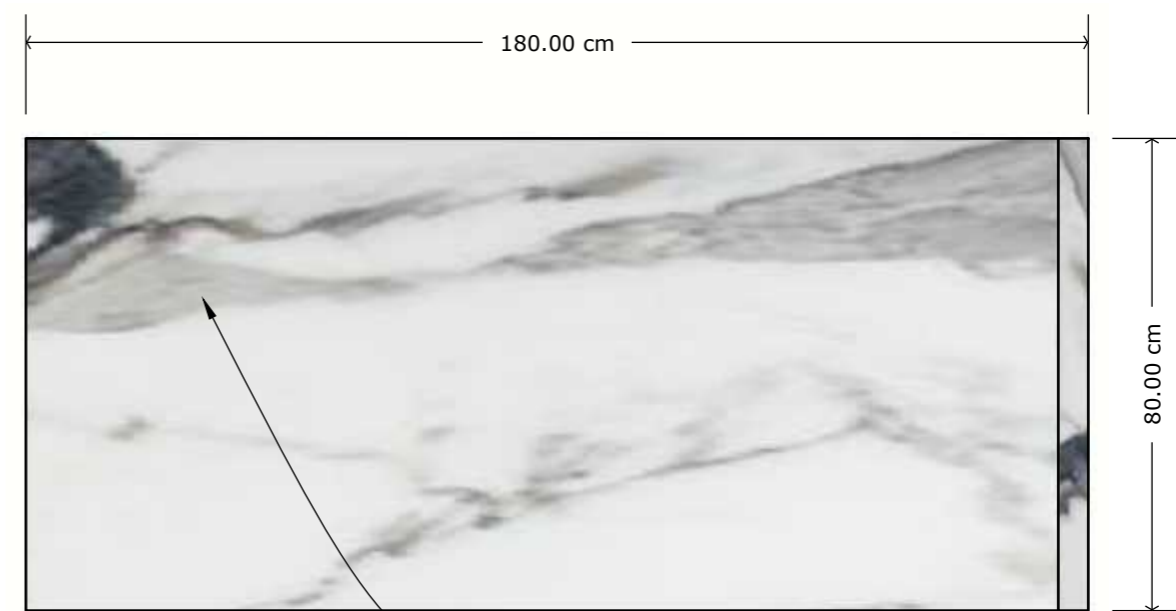

VISTA EN PLANTA



**DETALLES MUEBLE 02**  
MEDIDAS GENERALES GAVETEROS

PROYECTO:  
DISEÑO DE COCINA - CASA INESTROZA  
CLIENTE: -----

ARQ. JORGE SANTOS

13/22

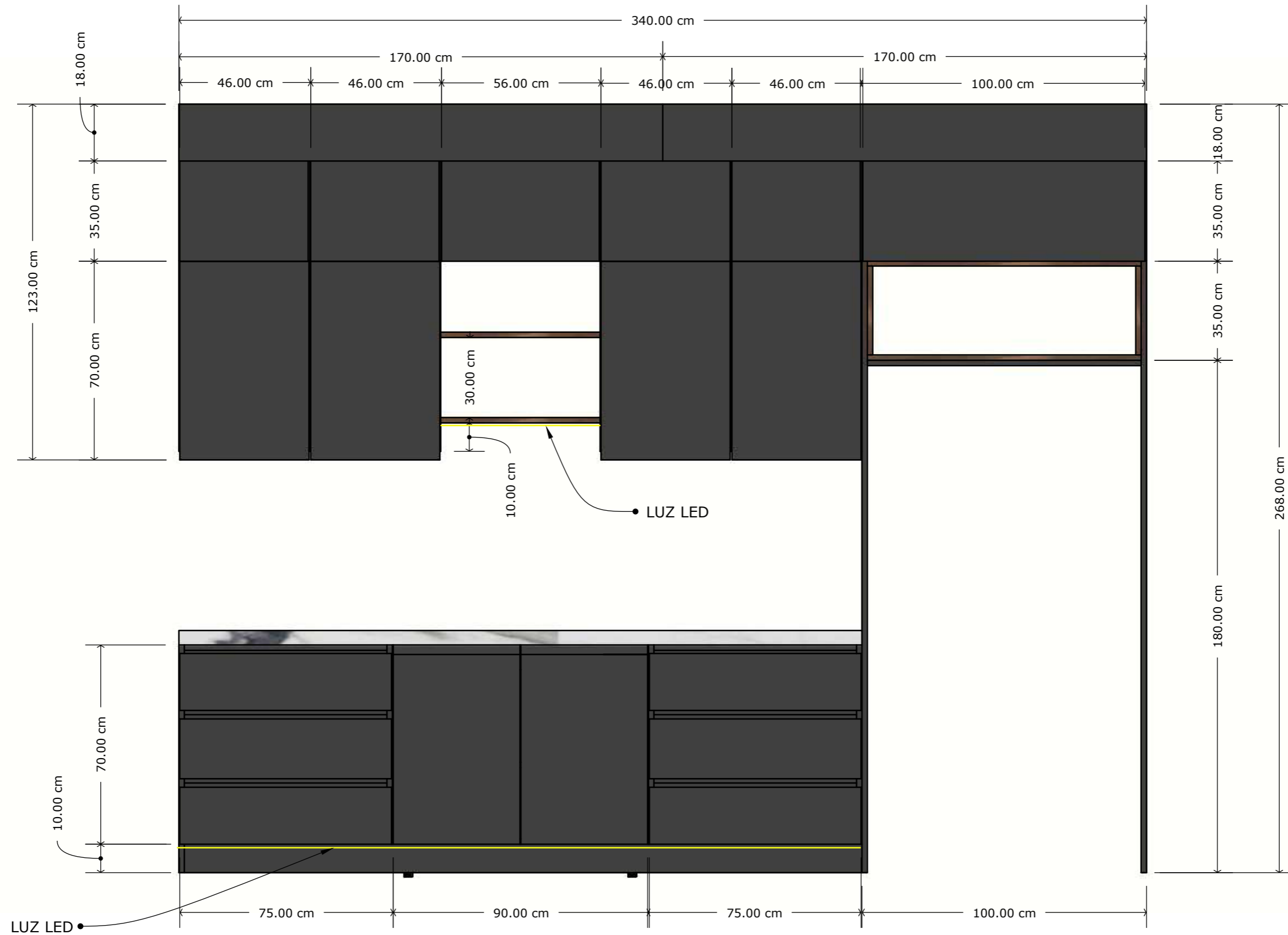

VISTA FRONTAL MUEBLE 03  
MEDIDAS GENERALES

PROYECTO:  
DISEÑO DE COCINA - CASA INESTROZA  
CLIENTE: -----

ARQ. JORGE SANTOS

14/22

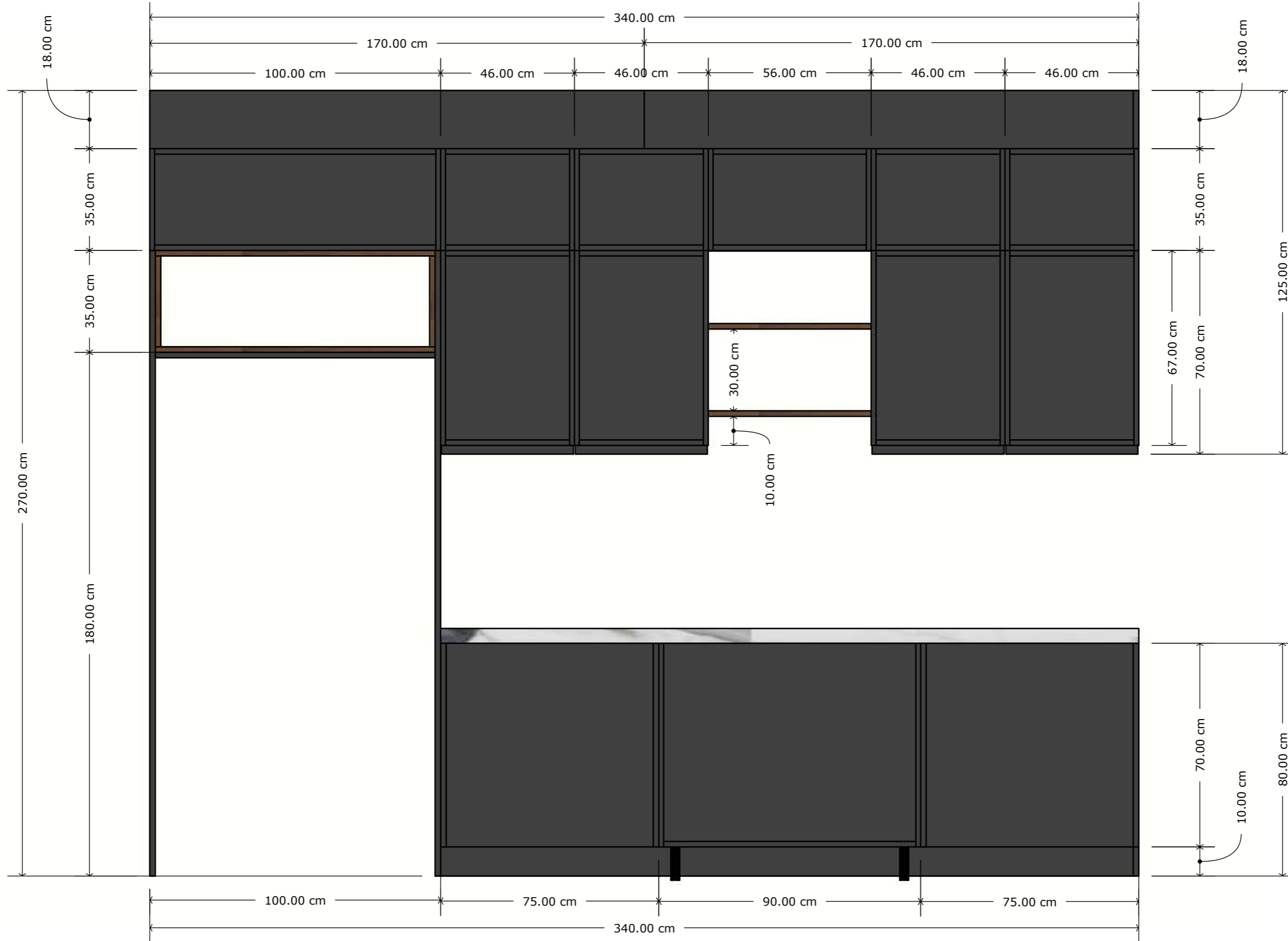

**VISTA TRASERA MUEBLE 03**  
 MEDIDAS GENERALES GAVETEROS

PROYECTO:  
 DISEÑO DE COCINA - CASA INESTROZA  
 CLIENTE: -----

ARQ. JORGE SANTOS

**15/22**

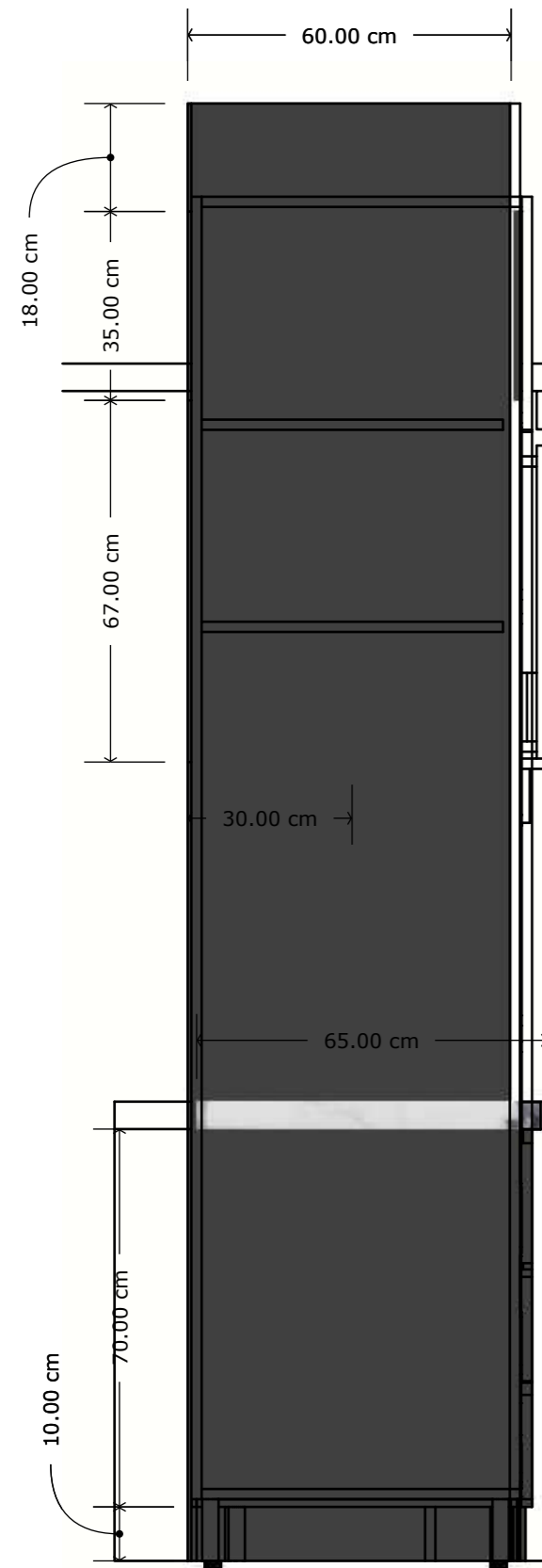

VISTA LATERAL IZQUIERDA MUEBLE 03

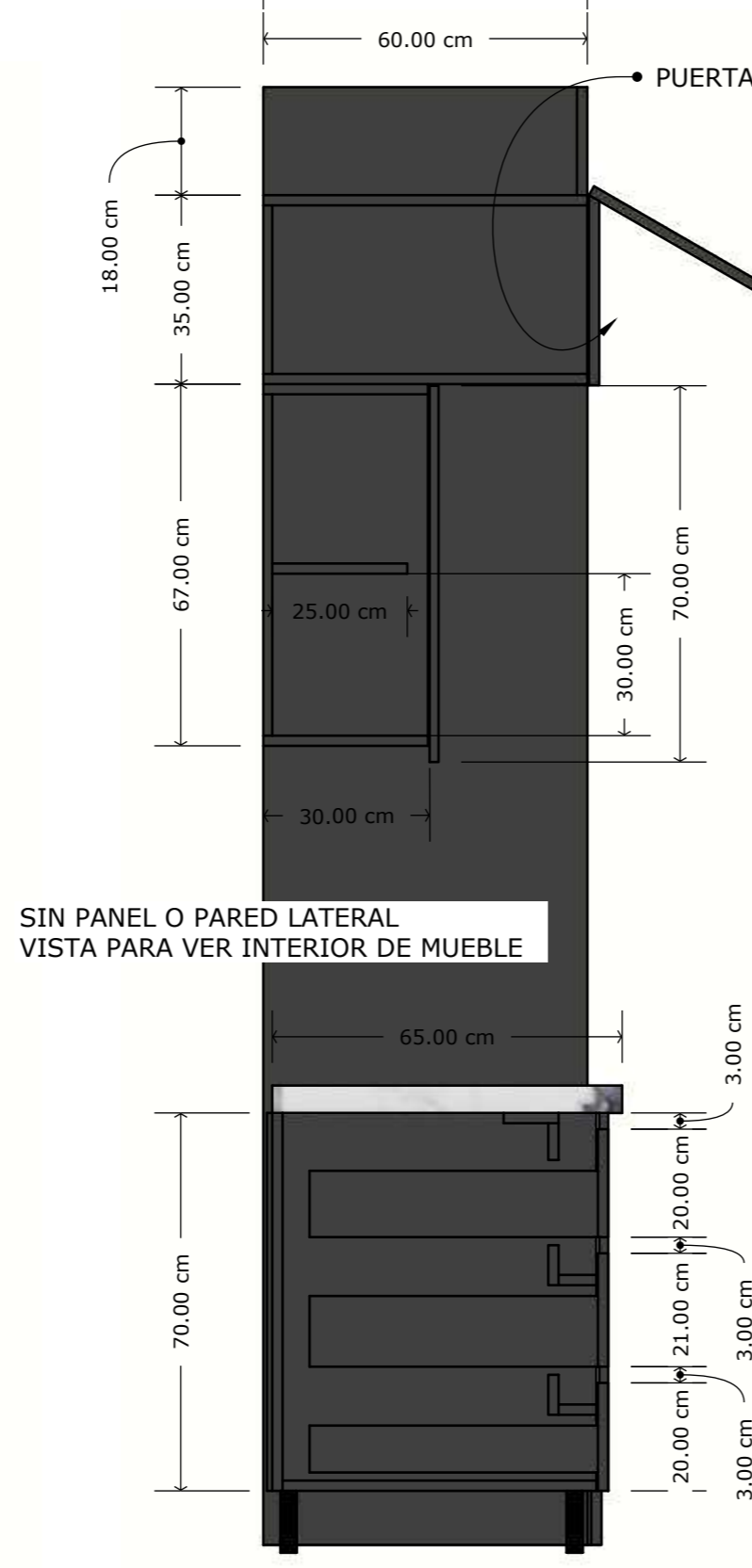

SIN PANEL O PARED LATERAL  
VISTA PARA VER INTERIOR DE MUEBLE

VISTA LATERAL IZQUIERDA MUEBLE 03

• PUERTA CON PUSH PARA APERTURA

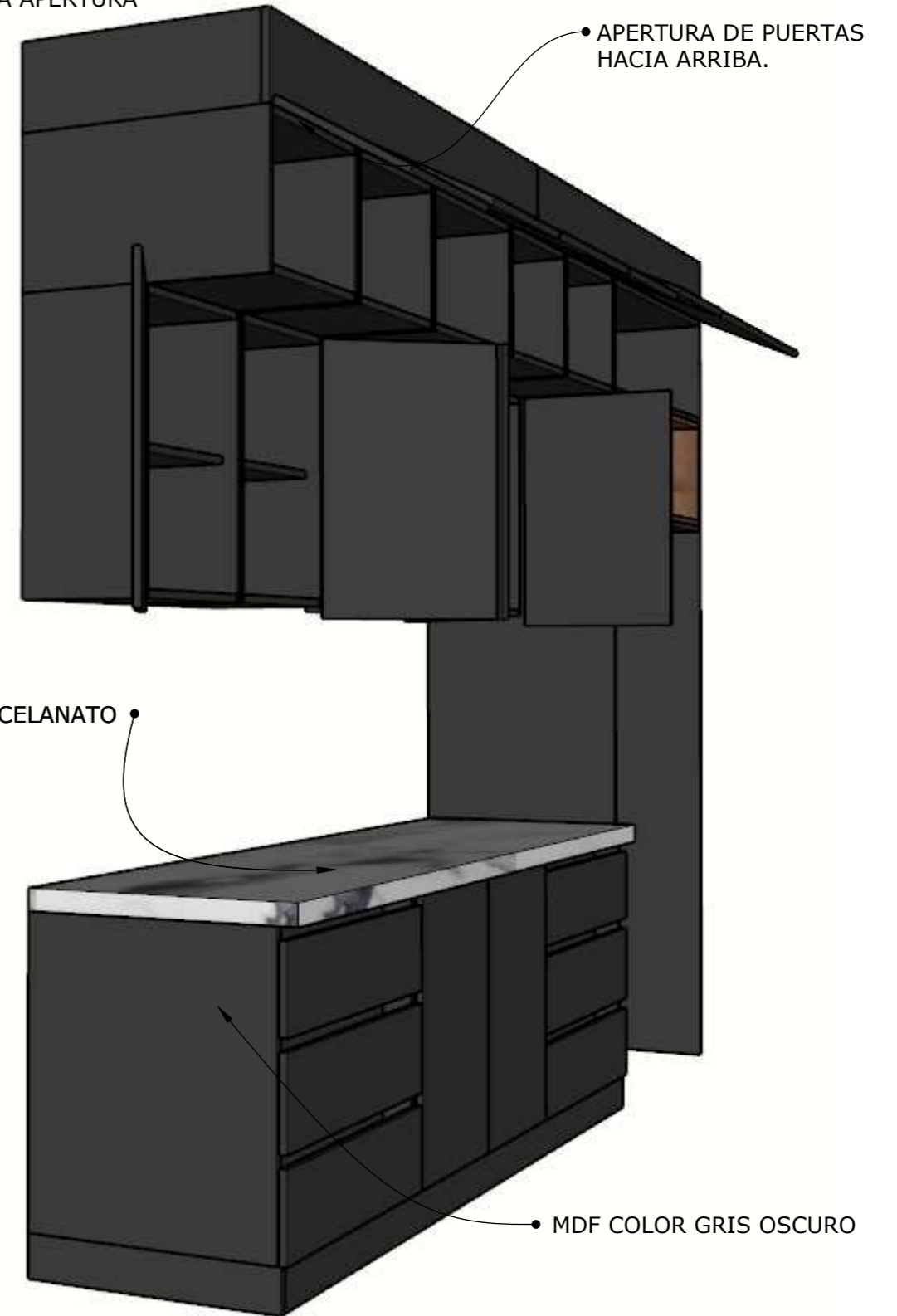

VISTA APERTURA DE PUERTAS



**DETALLES MUEBLE 03**  
MEDIDAS GENERALES GAVETEROS

PROYECTO:  
DISEÑO DE COCINA - CASA INESTROZA  
CLIENTE: -----

ARQ. JORGE SANTOS



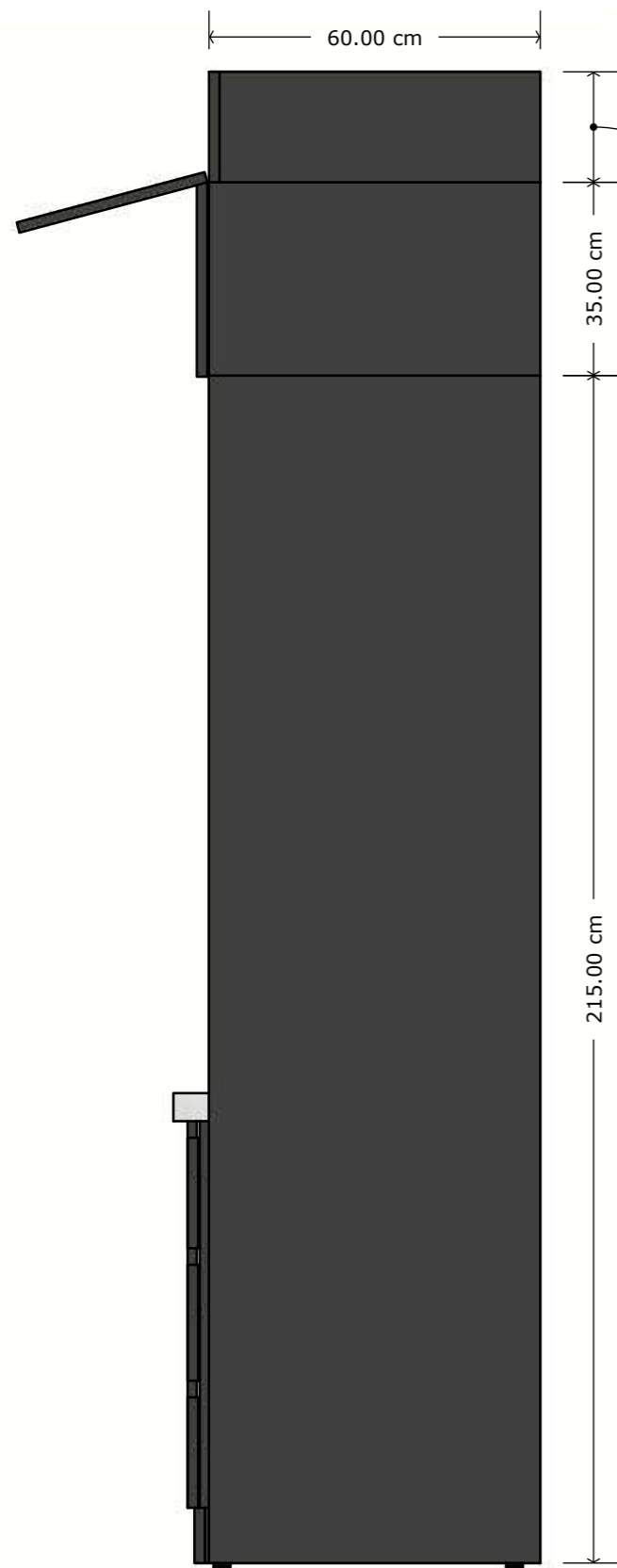

VISTA LATERAL IZQUIERDA MUEBLE 03

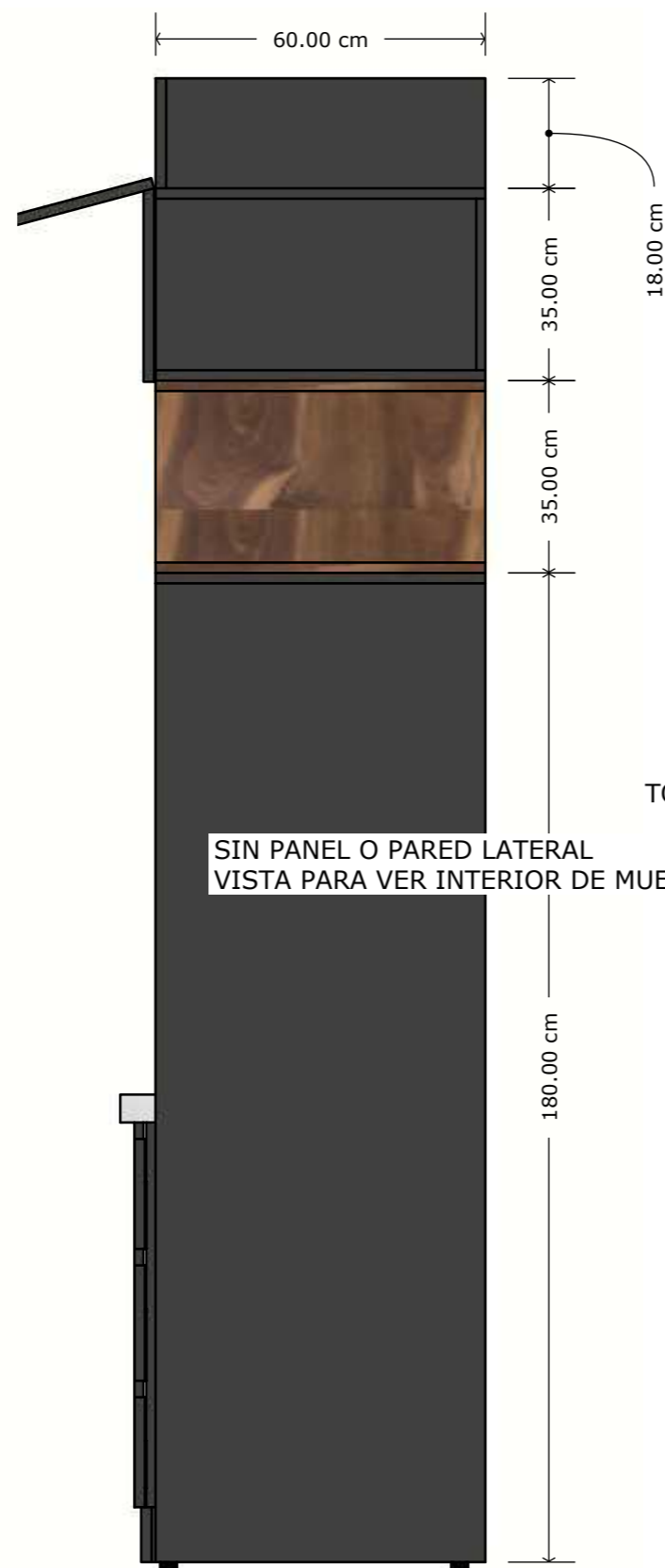

VISTA LATERAL IZQUIERDA MUEBLE 03

NO HAY PIEZA PORQUE ESTA PEGADO A LA PARED



VISTA APERTURA DE PUERTAS

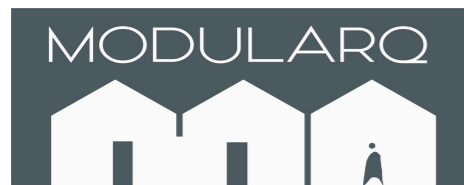

**DETALLES MUEBLE 03**  
MEDIDAS GENERALES GAVETEROS

PROYECTO:  
DISEÑO DE COCINA - CASA INESTROZA  
CLIENTE: -----

ARQ. JORGE SANTOS

17/22



**ISOMETRICO / DETALLE TOP DE PORCELANATO**



**VISTA EN PLANTA MUEBLE 03**  
TOP DE PORCELANATO

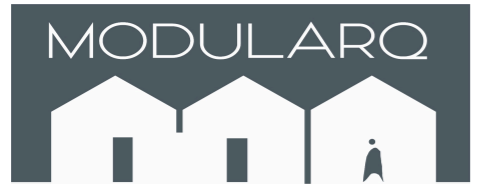

**DETALLES MUEBLE 03**  
MEDIDAS GENERALES GAVETEROS

PROYECTO:  
DISEÑO DE COCINA - CASA INESTROZA  
CLIENTE: -----

ARQ. JORGE SANTOS

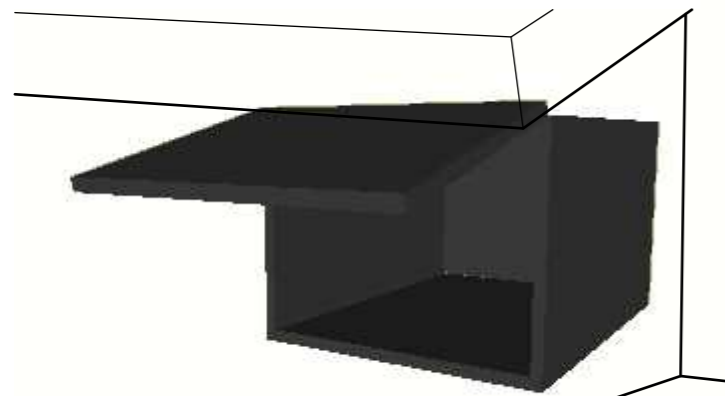

**ISOMETRICO**

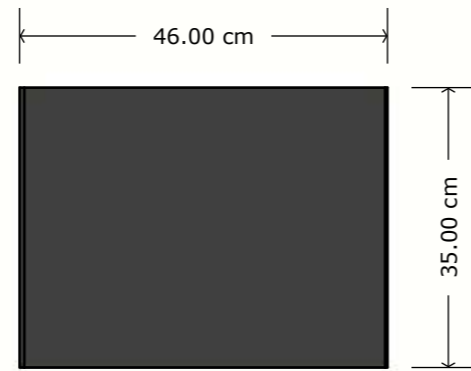

**VISTA FRONTAL**

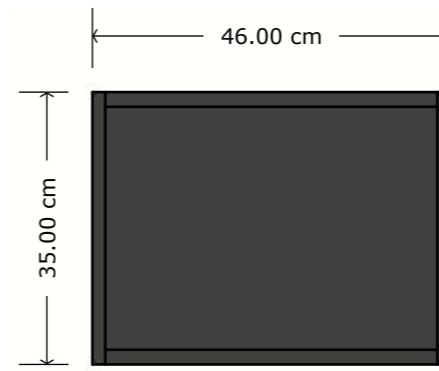

**VISTA POSTERIOR**

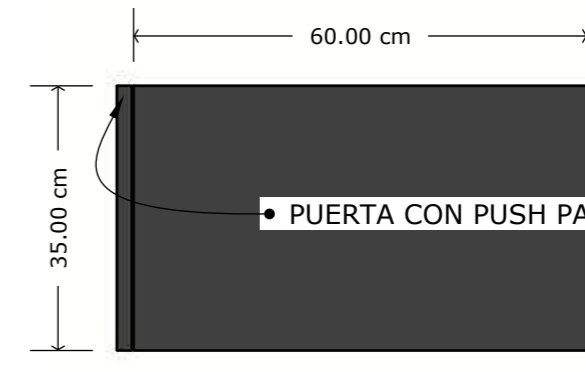

**VISTA LATERAL**

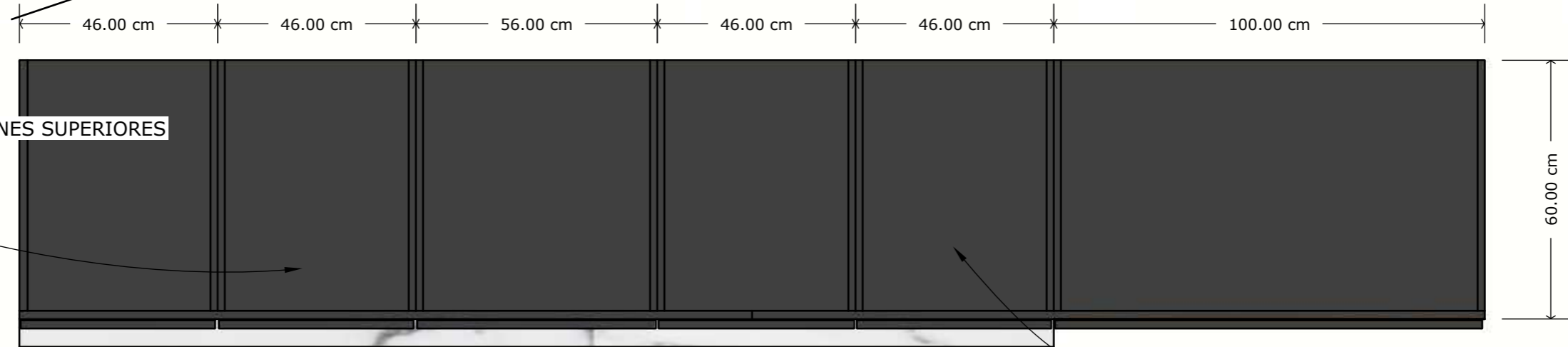

**VISTA SUPERIOR MUEBLE 01**

• APERTURA DE PUERTAS HACIA ARRIBA CON PUSH.

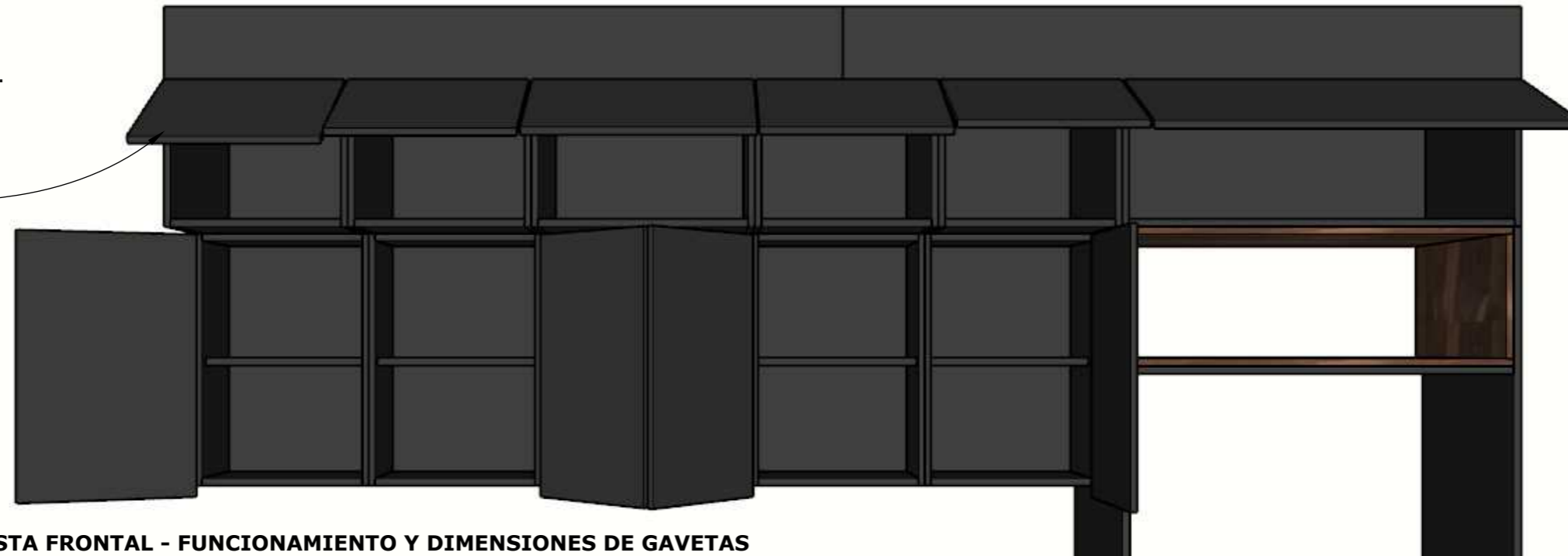

**VISTA FRONTAL - FUNCIONAMIENTO Y DIMENSIONES DE GAVETAS**



**DETALLES MUEBLE 03**  
MEDIDAS GENERALES GAVETEROS

PROYECTO:  
DISEÑO DE COCINA - CASA INESTROZA  
CLIENTE: -----

ARQ. JORGE SANTOS

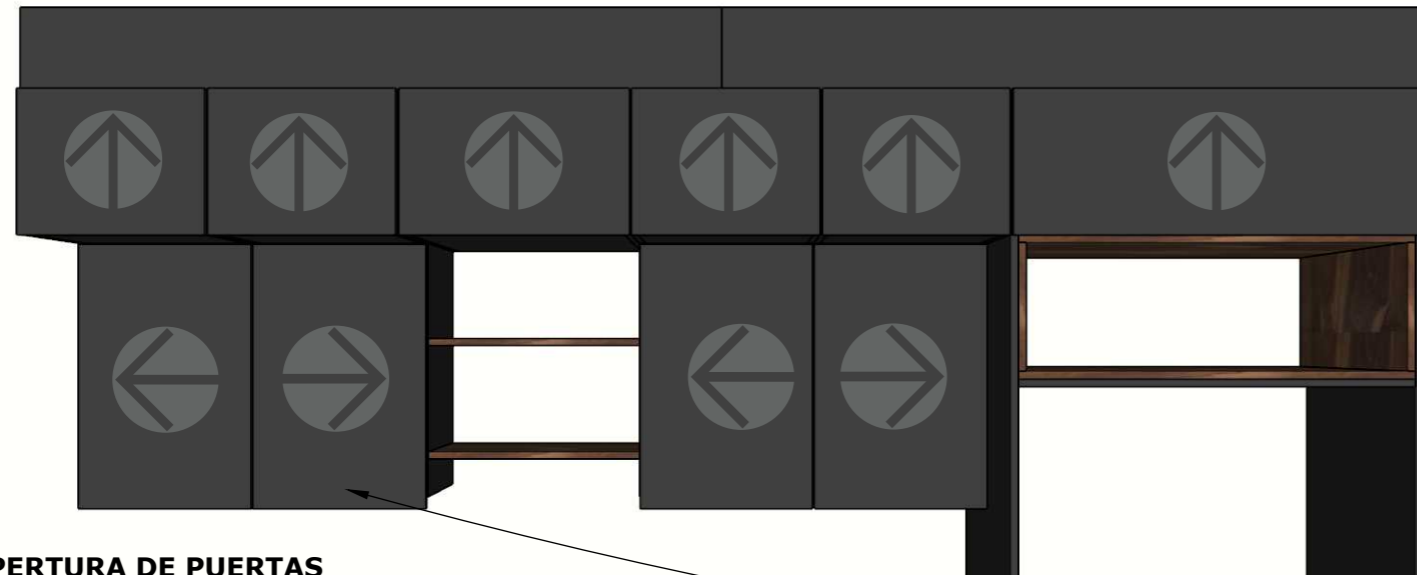

**APERTURA DE PUERTAS**

- APERTURA HACIA IZQUIERDA
- APERTURA HACIA DERECHA
- APERTURA HACIA ARRIBA

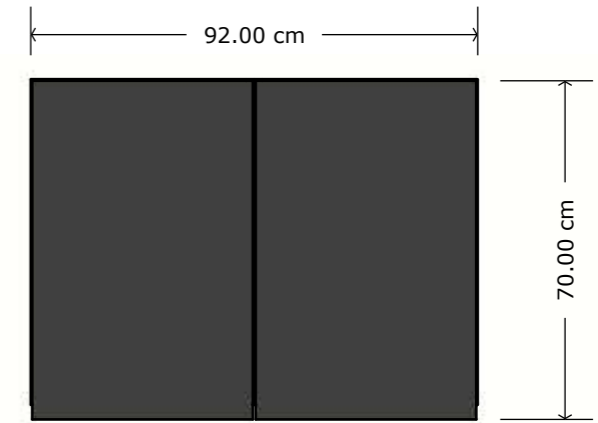

• **VISTA FRONTAL Y TRASERA**

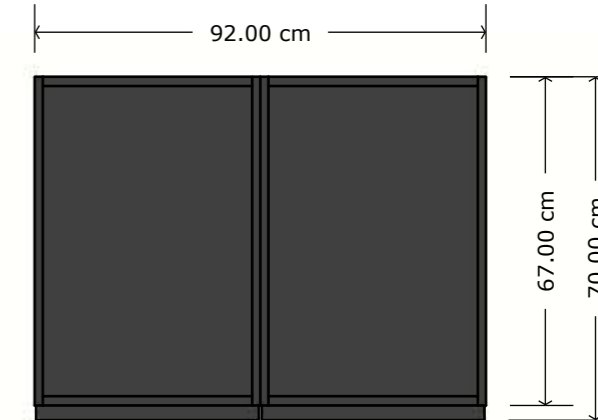

• **CAJONES SIN PUERTA PARA VER DIMENSIONES INTERNAS**

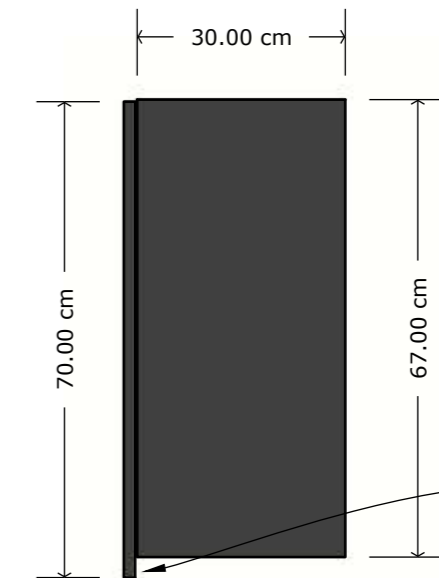

**VISTA LATERAL**

PIEZA SOBRESALE PARA APERTURA DE PUERTA

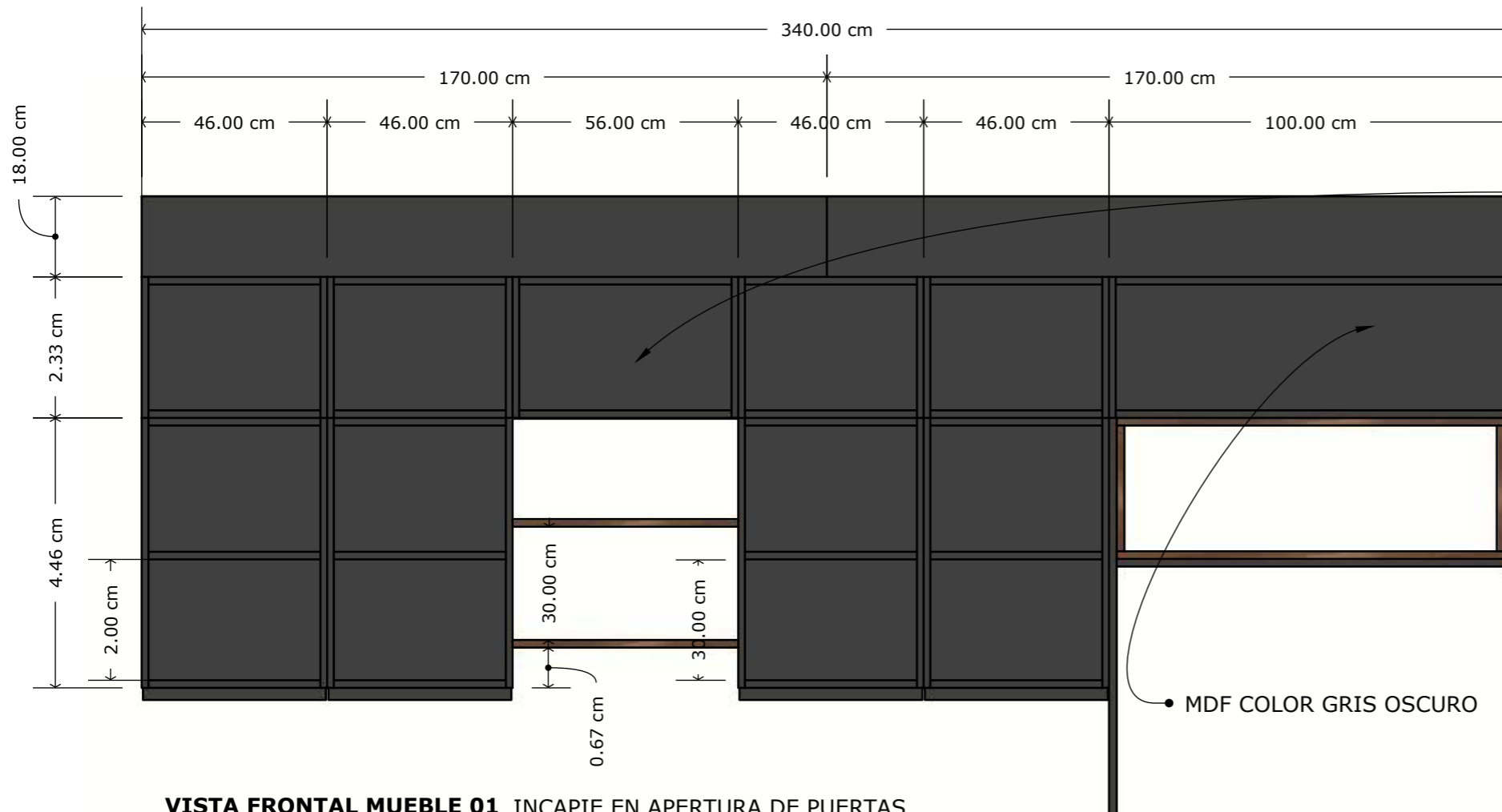

**VISTA FRONTAL MUEBLE 01** INCAPIE EN APERTURA DE PUERTAS

• **MDF COLOR GRIS OSCURO**

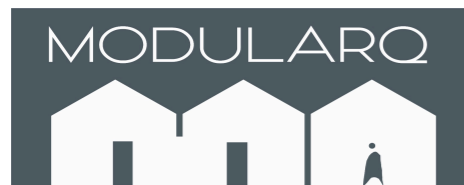

**DETALLES MUEBLE 03**  
MEDIDAS GENERALES GAVETEROS



PROYECTO:  
DISEÑO DE COCINA - CASA INESTROZA  
CLIENTE: -----

ARQ. JORGE SANTOS

**20/22**



**VISTA FRONTAL - FUNCIONAMIENTO Y DIMENSIONES DE GAVETAS**

 APERTURA HACIA IZQUIERDA    
  APERTURA HACIA DERECHA

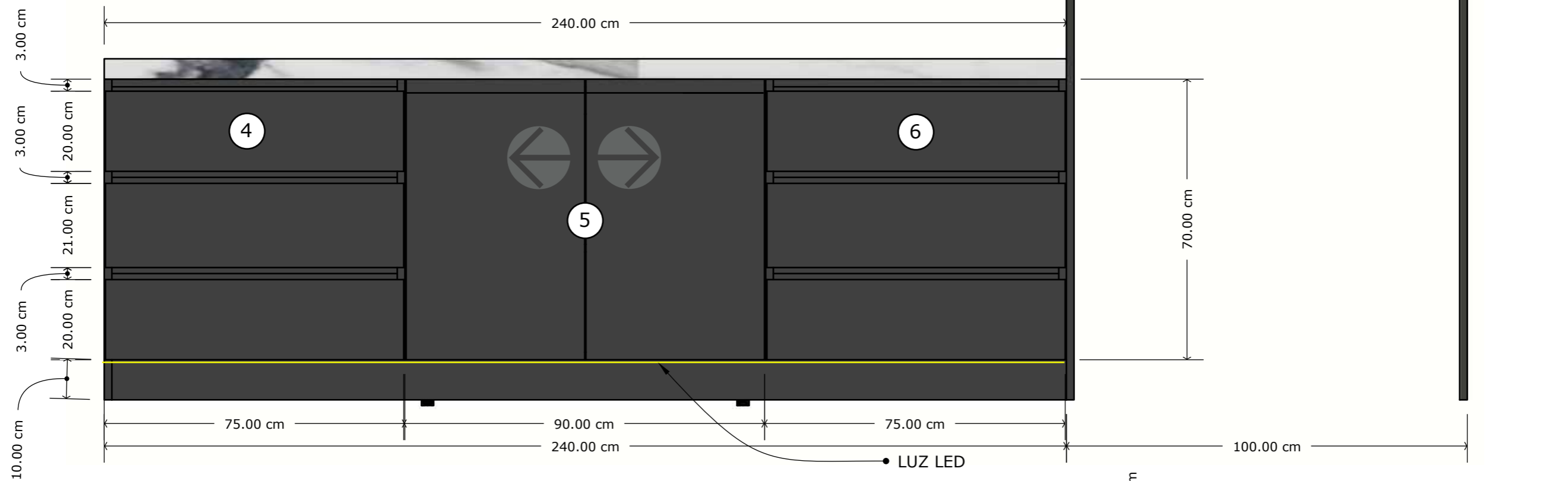

**ISOMETRICO** (4) (6)

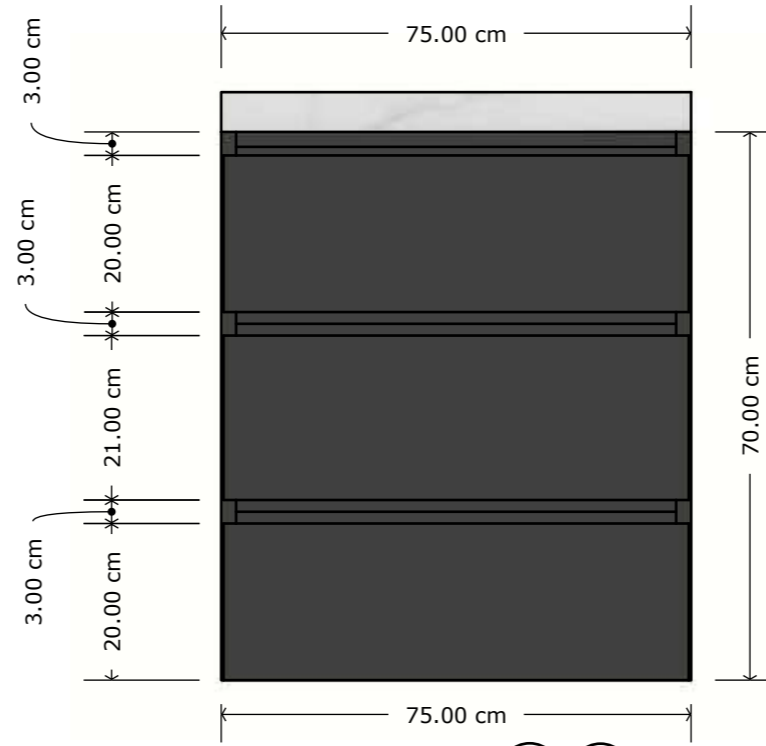

**VISTA FRONTAL** (4) (6)

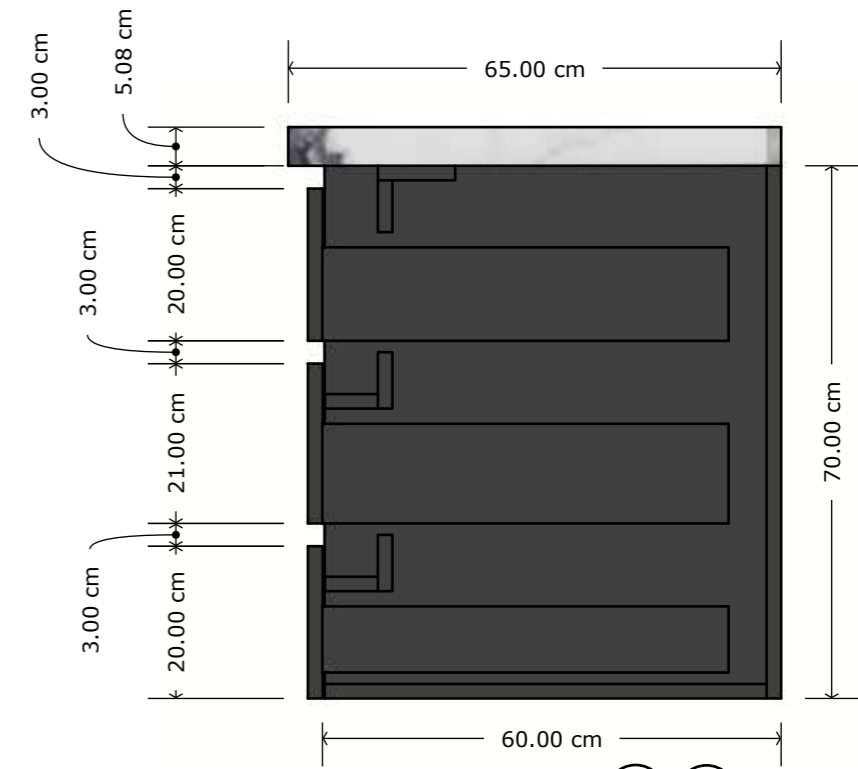

**VISTA LATERAL** (4) (6)





**DETALLES MUEBLE 03**  
MEDIDAS GENERALES GAVETEROS

PROYECTO:  
 DISEÑO DE COCINA - CASA INESTROZA  
 CLIENTE: -----

ARQ. JORGE SANTOS

**21/22**

**VISTA FRONTAL - FUNCIONAMIENTO Y DIMENSIONES DE GAVETAS**

 APERTURA HACIA IZQUIERDA   
  APERTURA HACIA DERECHA

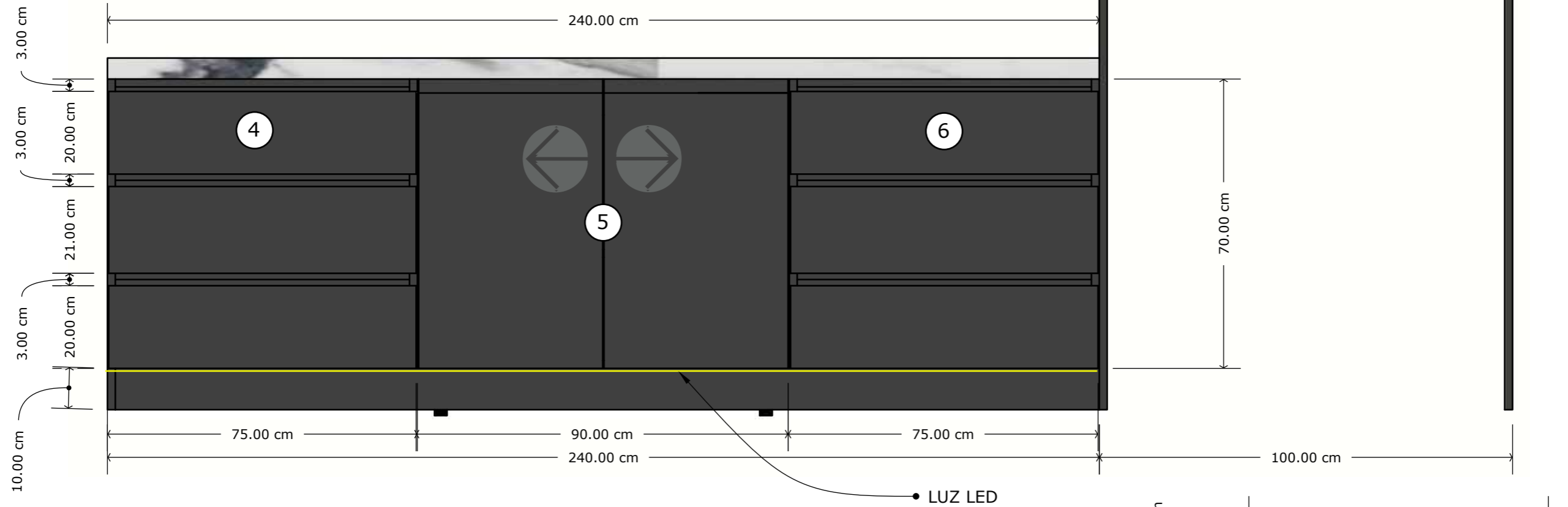

ISOMETRICO (5)

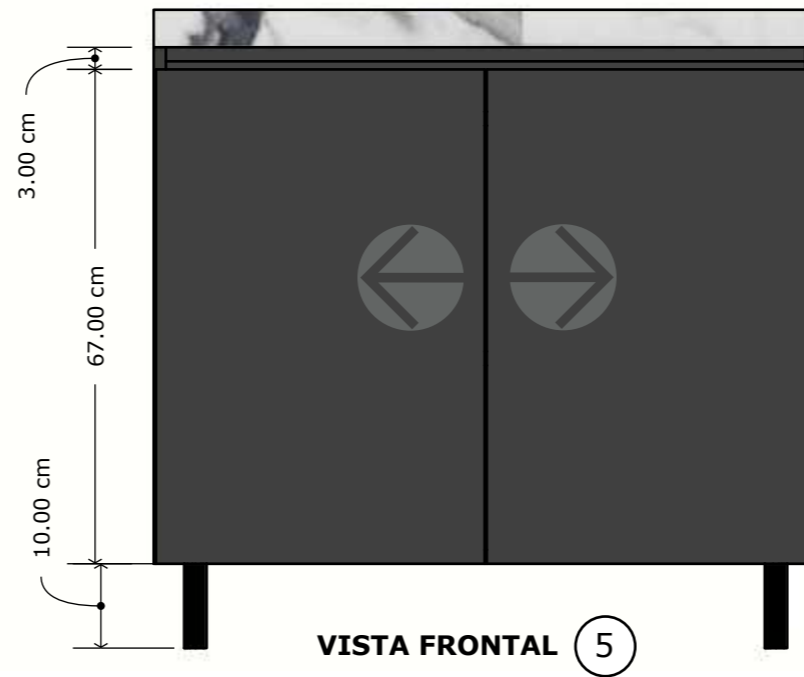

VISTA FRONTAL (5)

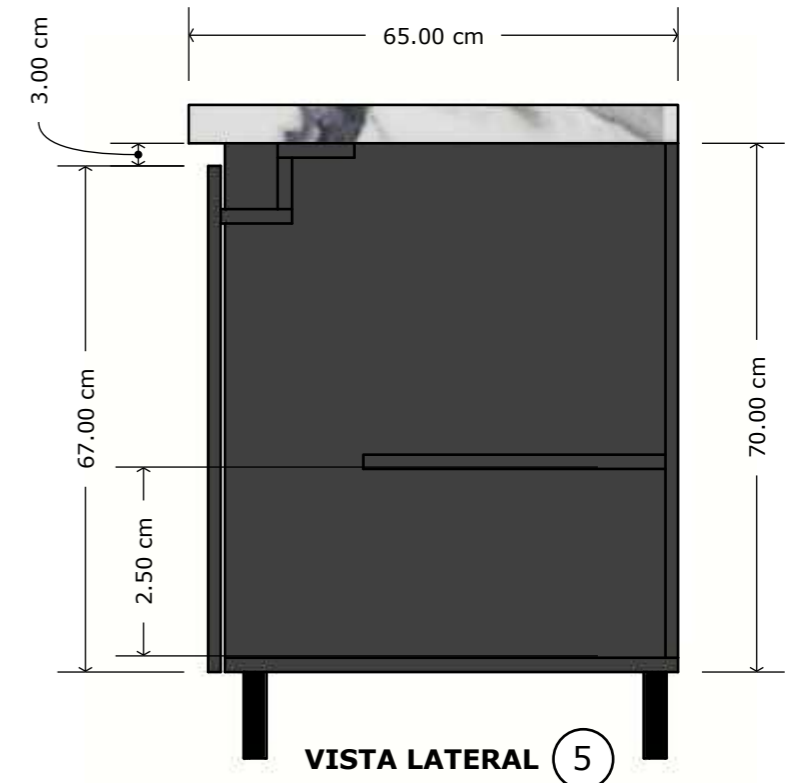

VISTA LATERAL (5)



**DETALLES MUEBLE 03**  
MEDIDAS GENERALES GAVETEROS

PROYECTO:  
 DISEÑO DE COCINA - CASA INESTROZA  
 CLIENTE: -----

ARQ. JORGE SANTOS

**22/22**